

Envirotainer^o

Precision with Purpose

RKN t2 container Operations Manual

**RKN container,
120005R(), 120005R-A-()-()**

Doc No. MO-RKN-3062
Version 28

www.envirotainer.com

Doc No:	Revision:	State	Release date:	Approved by
MO-RKN-3062	28	Released	2025-06-13	lindaw

RECORD OF REVISION

VER. NO.	REVISION
27	REVISED: <ul style="list-style-type: none">• Front page: Revised layout and added P/N 120005R-A-()-().• 2.1.2 Symbols on the container: Added NED sticker.• 4.4.6 Loading cargo: Removed note regarding airline approved straps and removed “airline approved” in the instruction to now simply say “straps”.

TABLE OF CONTENTS

1. INTRODUCTION.....	1
1.1 Intended use	1
1.2 Manufacturer	1
1.3 Contact.....	1
1.4 How to use the manual	1
2. SAFETY.....	2
2.1 Symbols	2
2.1.1 Symbols in the manual	2
2.1.2 Symbols on the container	3
2.2 Safety instructions	4
2.2.1 General.....	4
2.2.2 Handling dry ice	4
3. CONTAINER DESCRIPTION.....	5
3.1 Orientation conventions	5
3.2 Overview	6
3.3 Refrigeration system operation	7
3.4 Attachment points for security seals	8
3.5 Set temperature range	8
3.6 Loading capacity	9
3.7 Operating conditions.....	9
3.8 Battery duration.....	10
4. USING THE CONTAINER	11
4.1 Preparing a shipment.....	12
4.2 Shipping	13
4.3 Finishing a shipment.....	14
4.4 Operating instructions.....	15
	→

4.4.1	Lifting and moving the container	15
4.4.2	Mounting or removing batteries	17
4.4.3	Handling dry ice	19
4.4.4	Pre-conditioning cargo and container	21
4.4.5	Recording temperatures	23
4.4.6	Loading cargo.....	25
4.4.7	Handling the container during shipment	30
4.4.8	Unloading the container.....	31
4.4.9	Storing the container	32
4.4.10	Operating the control unit	33
5.	TROUBLESHOOTING.....	40
5.1	Alerts.....	40
5.2	Alarms.....	41
5.3	Hardware.....	42
6.	CALCULATING DRY ICE AMOUNTS.....	46
6.1	Calculate dry ice amount for container pre-conditioning	47
6.2	Calculate dry ice amount for container shipment	48
7.	DRY ICE TABLES.....	49
7.1	Set temperature +5°C	49
7.2	Set temperature -20°C	49
8.	TECHNICAL SPECIFICATION.....	50
8.1	Definition of dimensions	51
8.2	Loading space.....	52

1. INTRODUCTION

This manual provides information for personnel involved in the operation of Envirotainer container series RKN t2 and is published by Envirotainer AB without warranty.

1.1 INTENDED USE

The RKN t2 is a temperature controlled air cargo container designed to transport temperature controlled products with temperature ranges below -18 °C (-1 °F), from +2 to +8 °C (+36 to +47 °F) and from +2 to +25 °C (+36 to +77 °F). It is intended for use in aircrafts, trucks and trains. The container may also be transported by ship when empty or loaded with non temperature sensitive cargo.

The container can be used indoors or outdoors. Operating conditions when transporting temperature sensitive cargo are stated in **3.7 Operating conditions**.

The container may only be handled and operated by trained personnel, and in accordance with the instructions given in this manual. Operational limitations regarding maximum gross weight and ambient temperatures stated in **8. Technical specification** must not be exceeded.

If applicable, the use of the container must follow the "IATA Dangerous Goods Regulations".

1.2 MANUFACTURER

The container is manufactured and provided by:

Envirotainer Engineering AB

Staffans väg 2A

SE-192 78 Sollentuna

SWEDEN

1.3 CONTACT

For contact information to our operations centers, refer to www.envirotainer.com.

For questions regarding the container or for reporting misleading, incorrect or insufficient data in the manual, send an e-mail to support@envirotainer.com.

1.4 HOW TO USE THE MANUAL

Before handling and operating the container, carefully read and understand chapter **2. Safety**, and get acquainted with the container and the operating conditions in chapter **3. Container description**.

When handling the container before, during and after shipment*, follow the checklists in chapters **4.1 Preparing a shipment**, **4.2 Shipping** and **4.3 Finishing a shipment** to make sure that all necessary measures for a successful shipment are taken. The checklists contain references to relevant operating instructions.

If any problem should arise, refer to chapter **5. Troubleshooting** for possible solutions.

* Definitions of the three shipment stages are found in **4. Using the container**.

2. SAFETY

This chapter contains safety instructions and explanations of safety related symbols in the manual and on the container. For safe handling of the container, make sure to read the instructions before use, and pay attention to the warning stickers attached to the container.

2.1 SYMBOLS

2.1.1 SYMBOLS IN THE MANUAL

The following symbols are used in the manual:

 **WARNING!**

Indicates a possible danger that **can** lead to death or serious injury if necessary measures are not taken.

 **CAUTION!**

Indicates a possible hazard that **can** lead to injury or material / equipment damage if necessary measures are not taken.

 **NOTE!**

Practical information or tips on how to perform a procedure.

2.1.2 SYMBOLS ON THE CONTAINER

This section contains explanations of safety related symbols and stickers on the container, and information about where they are found.

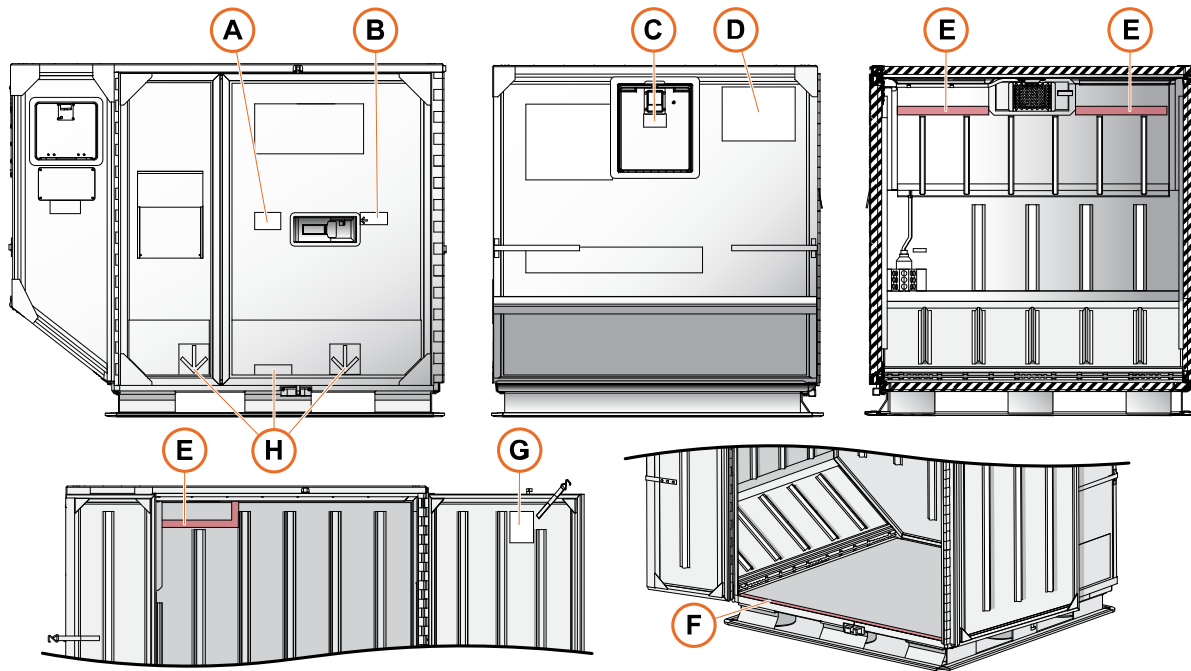

Fig. 1 Placement of stickers on the container

G00005221

Table 1 Stickers on the container

Pos	Sticker	Explanation
A	“Perishables Handle with care”	Make sure to handle the container carefully, as it contains perishables.
B	“Caution! Watch your fingers!”	Risk of crush injury. Be careful when handling the door lock. The sticker is only applicable for one out of two available door lock models, and is therefore not applied on all containers.
C	“Caution! Dry ice”	The lid provides access to the dry ice bunker, which contains dry ice. Refer to 2.2 Safety instructions for safe handling of dry ice.
D	ODLN sticker	The container is labeled with an Operational Damage Limits Notice (ODLN) sticker, to meet the IATA labelling requirements for aircraft containers. The ODLN describes the acceptable damage limits from an airworthiness perspective and can be used for safe loading onto the aircraft. Before every lease, the containers are inspected against even stricter criteria than those stated on the ODLN. Therefore, the container will never exhibit the level of damage as described on the ODLN when released from an Envirotainer station.
E	Red line	The red line indicates an area that must be kept clear in order for the fan to work properly. Do not load any cargo in this area.
F	“Do not load cargo in the red area”	The red line indicates the end of the loading space. Do not load cargo on or outside the red line.

→

Table 1 Stickers on the container (cont'd.)

Pos	Sticker	Explanation
G	Loading instruction	The sticker contains important loading instructions. Make sure to follow the instructions during cargo loading.
H	“FORKLIFT” and “Arrow”	When moving the container with forklift, insert the forklift forks into the forklift pockets as indicated by the arrows.
		The NED sticker serves as a temporary repair method, sealing minor defects in the outer surface, preventing moisture and dirt from entering. This reduces unnecessary transports and also contributes to environmental sustainability. The defect beneath the sticker has no effect on the container's airworthiness or functionality.

2.2 SAFETY INSTRUCTIONS

For safe handling of the container, read the instructions before use, and pay attention to warning stickers attached to the container.

2.2.1 GENERAL

 **CAUTION!**

Always follow the "IATA Dangerous Goods Regulations" when loading the container. For example, if transporting dangerous goods such as liquids with low boiling point, special consideration should be given to the fact that the container may not be able to maintain the temperature in the cargo space in case of low battery level or malfunction.

 **CAUTION!**

Observe normal precautions when handling locks, doors and lids.

2.2.2 HANDLING DRY ICE

 **WARNING!**

The dry ice used as refrigerant is considered a Class 9 dangerous cargo with the UN identification number 1845 and is described as “Carbon Dioxide, Solid”.

 **WARNING!**

Risk of suffocation! Dry ice sublimates into large amounts of CO₂ gas. This colorless, odorless gas is heavier than air and can accumulate and displace oxygen in low areas. Do not enter areas where CO₂ may have accumulated without first ventilating the space. When handling dry ice, work as fast as possible, and do not work alone.

 **WARNING!**

Risk of severe frost bite! Do not allow contact between dry ice and skin or eyes. Dry ice is extremely cold (-78.5 °C (-109 °F)), and severe frostbite can occur within seconds. Always wear gloves or other insulating material when handling dry ice.

3. CONTAINER DESCRIPTION

3.1 ORIENTATION CONVENTIONS

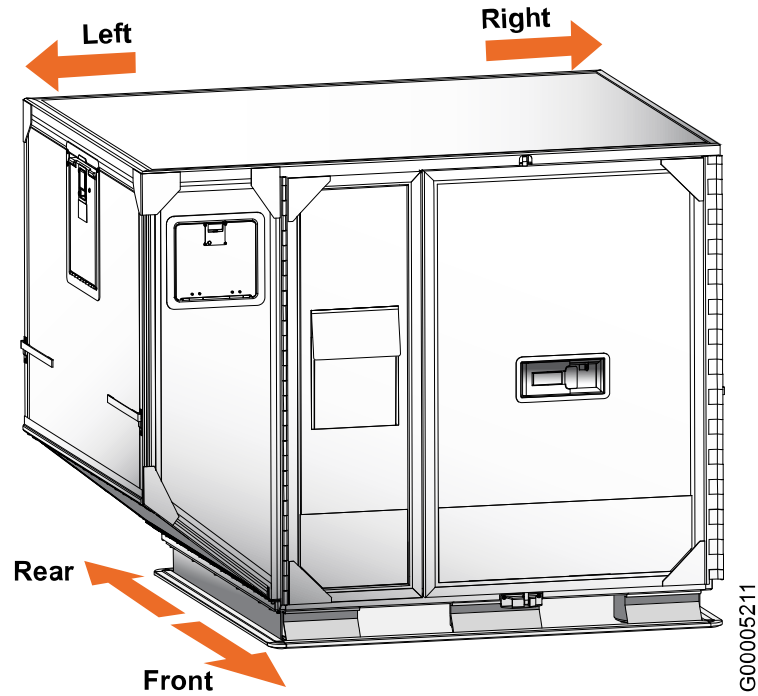

Fig. 2 Schematic view of the container with orientation conventions

3.2 OVERVIEW

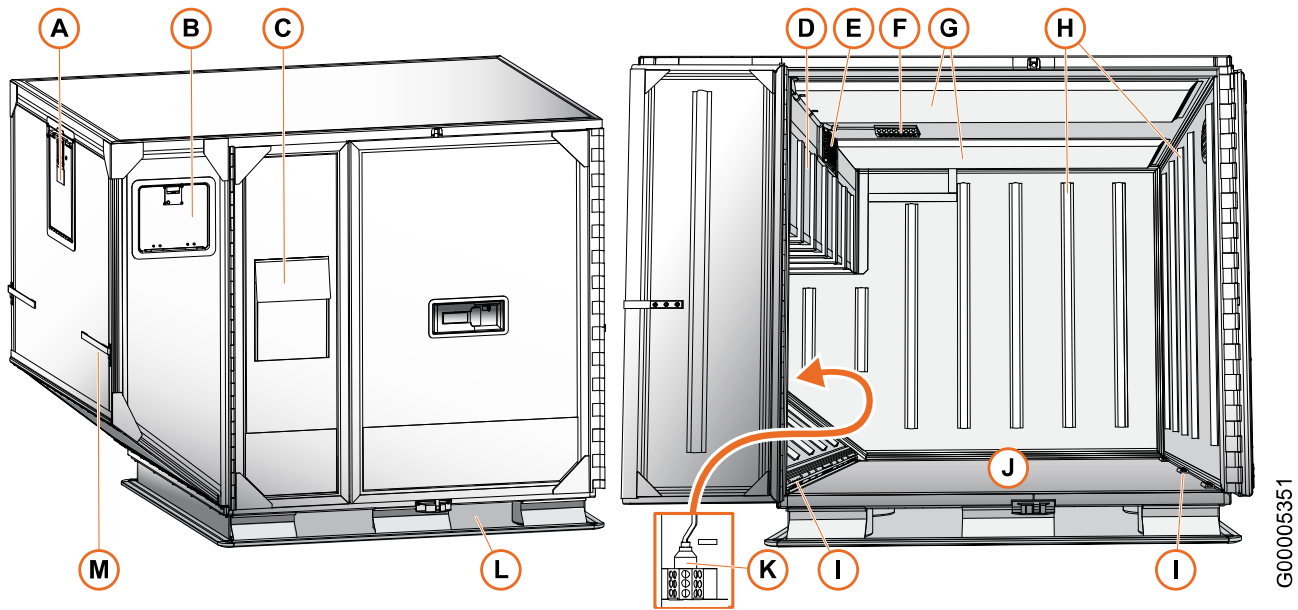

Fig. 3

G00005351

Table 2 Container features

Pos	Name	Description
A	Dry ice bunker lid	For insertion and removal of dry ice.
B	Control unit	For turning the container on/off, changing settings and viewing information. Contains a battery compartment holding the batteries that power the control unit and fan. Can be sealed with a security seal.
C	Document pouch	For shipping documents, checklists etc.
D	Cooling unit	Contains dry ice. Cools the air to keep the cargo space at the required temperature.
E	Fan	Circulates air in the container via the refrigeration system and air guides.
F	Temperature sensor	Monitors the cargo space temperature and sends signals to the control unit.
G	Air guide	Distributes cooled air into the cargo space.
H	Spacer	Secures a distance between the cargo and the container walls for air circulation purposes.
I	Internal tie-down bracket	Attachment point for cargo straps, to secure the cargo.
J	Cargo space	Temperature controlled area for cargo.
K	Condensing water bottle	Collects condensing water from the cooling system.
L	Forklift pocket	Insertion point for forklift forks.
M	Strap handle	For handling the container on roller beds.

3.3 REFRIGERATION SYSTEM OPERATION

For the refrigeration system to operate, the dry ice bunker must be loaded with dry ice as refrigerant, and the control unit must be equipped with D-cell alkaline batteries.

The required cargo space temperature is set on the control unit, and maintained using cooled air that is circulated between the cooling unit and the cargo space. Air from the cooling unit is blown into the cargo space through the air guides in the ceiling. The circulated air is then drawn back into the cooling unit through the fan, as indicated with arrows in the figure. The returned air is circulated in a space around the dry ice bunker for cooling, before being blown back into the cargo space.

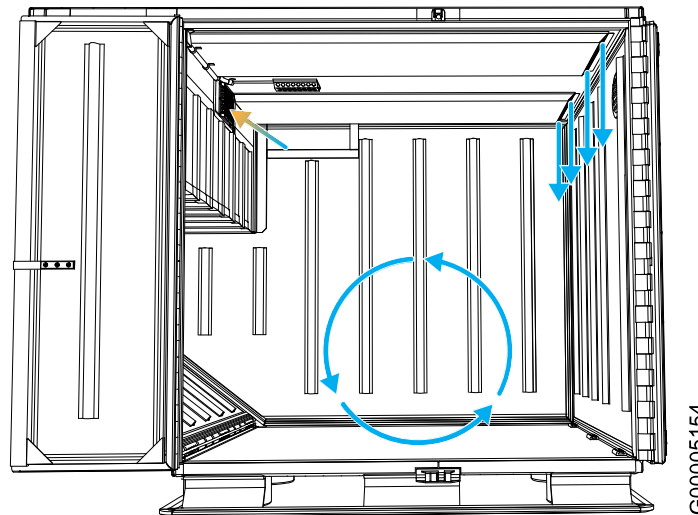

Fig. 4 Schematic view of the internal airflow

The fan is controlled by a thermostat in the control unit. The thermostat responds to signals from the temperature sensor in the cargo space, and turns the fan on or off as required depending on the current temperature in relation to the set temperature. The software in the control unit has a regulation algorithm that makes the temperature fluctuate around the set temperature to obtain a hysteresis between the ON and OFF boundaries. It is therefore normal that the fan is running even if the container temperature is lower than the set temperature.

During the shipment, the energy from the batteries and dry ice is consumed, and eventually the container enters “torpor mode” and the fan stops. The operating time before the container enters torpor mode depends on the affecting parameters such as set temperature, ambient conditions, and quality and amount of the power sources.

The control unit displays alarms and warnings as needed to inform the user of system functionality.

For additional technical data, refer to **8. Technical specification**.

NOTE!

“Torpor mode” is a voltage cut-off limit set at 8.0 V. For containers equipped with software version 3.5 or later, this limit is lowered to 7.1 V. When “torpor mode” is reached the fan stops but the control unit will continue to operate and function normally.

3.4 ATTACHMENT POINTS FOR SECURITY SEALS

The container is equipped with two attachment points for security seals:

- One on the door lock (A)
- One on the control unit lid (B)

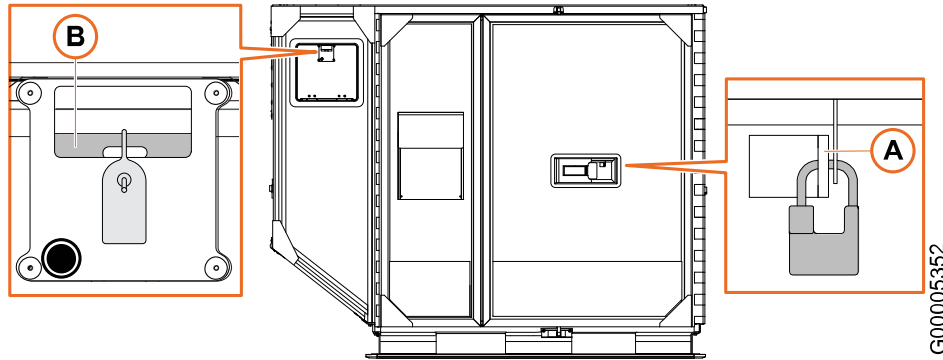

Fig. 5 Attachment points for security seals

Sealing the doors and the control unit lid before shipment can prevent (or help to detect):

- theft or contamination of cargo
- theft of batteries from the control unit
- accidental or deliberate tampering with the control unit settings

i NOTE!

It is possible to view information on a sealed control unit, but the settings cannot be changed.

Envirotainer recommends sealing at least the doors. If the control unit is sealed, be aware that the battery compartment is sealed as well, and that the seal must be broken for battery replacements.

Refer to **Table 3** for recommended security seal properties per attachment point. Note however that the effectiveness of a security seal is dependent on the way that it is used, and that procedures for record keeping, installation, inspection, removal and disposal are required.

Table 3 Recommended security seal properties

Placement	Properties
Doors	Maximum Ø 4,5 mm (0.18")
Control unit	Ø 2-4 mm (0.08-0.16")

3.5 SET TEMPERATURE RANGE

The container can be set at any temperature between -40 and +50 °C (-40 and +122 °F) with increments of 0.5 °C. This is the available range of set temperatures. For temperature control capability of the container, refer to section **3.7 Operating conditions**.

3.6 LOADING CAPACITY

The RKN t2 is an LD-3 air cargo container designed to hold the following number of standard pallets:

Table 4 Loading capacity

Pallet	Max pcs	Pallet size
EURO	1	1200 x 800 mm (47.3 x 31.5")
US	1	1220 x 1016 mm (48 x 40")

3.7 OPERATING CONDITIONS

The maximum operating time for the container depends on a combination of the available battery power, battery power consumption rate, type and amount of loaded dry ice, dry ice sublimation rate and ambient conditions. Therefore, to ensure a successful shipment, the following conditions must apply:

- The cargo and the container must be pre-conditioned to the required set temperature.
Refer to **4.4.4 Pre-conditioning cargo and container**.
- The correct set temperature must be set on the control unit.
Refer to **4.4.10 Operating the control unit**.
- The required type and amount of dry ice must be used.
Refer to **4.4.3.3 Using wrapped or unwrapped dry ice** and **6. Calculating dry ice amounts**.
- The container must have sufficient battery power throughout the shipment.
Refer to **4.4.10.5 Check the battery voltage**.
- The cargo must be loaded onto a pallet, and safely strapped in the container.
Refer to **4.4.6 Loading cargo**.
- The container must not be exposed to ambient temperatures outside the recommended range:
 - For refrigerated and “do not freeze” cargo: Recommended ambient temperature is 5 to 25 °C (9 to 45 °F) above the set temperature. Avoid exposing the loaded container to temperatures near or below the set temperature, as the container does not provide heating. Refer to **Table 5** for a description of the container performance at set temperature +5 °C (41 °F) relative to different ambient temperature ranges.
 - For deep frozen cargo: The container can be operated in ambient temperatures up to 30 °C (86 °F).
 - For both refrigerated, “do not freeze” and deep frozen cargo: Avoid exposing the loaded container to direct sunshine and/or extreme temperatures, as it would increase the dry ice consumption rate. Always take exposure to extreme ambient conditions into account when calculating the required amount of dry ice.

Table 5 Container performance at set temp +5 °C (41 °F)

Ambient temperature	Container performance at set temp +5 °C (41 °F)
High: > +30 °C (+86 °F)	The container can maintain the container set temperature for a limited time, but the dry ice and battery consumption rate will increase. It is not recommended to expose the container to high ambient temperatures due to risk of hot spots and air segmentation in exposed areas.



Table 5 Container performance at set temp +5 °C (41 °F) (cont'd.)

Normal (recommended): +10 to +30 °C (+50 to +86 °F)	Normal container performance.
Low: < +10 °C (+50 °F)	The container can maintain the container set temperature for a limited time, but the risk of cold spots close to the cooling unit increases with time, depending on the amount and type of dry ice used. Low ambient temperatures are not safe for the cargo.

3.8 BATTERY DURATION

The maximum operating time without changing the batteries is 72 hours. The actual operating time of alkaline batteries depends on several factors:

- Dry ice amount – When the dry ice amount is low, the container will operate the fans continuously to increase the cooling effect, leading to faster battery depletion.
- Ambient temperature – When the container is exposed to extreme heat, the fans will need to operate continuously to maintain the set temperature.
- Battery temperature – Alkaline batteries drain more rapidly when operating at low temperature.
- Battery quality – The battery specification of LR20/ANSI/NEDA 13A allows a battery capacity between 12 000 and 18 000 mAh. It is important to choose batteries with high capacity for maximum performance. Some brands also perform better than others in the RKN t2 container. For guidance on which batteries have been found to perform well in the RKN t2 container, or how to plan your shipment, please contact Envirotainer Customer Service, support@envirotainer.com.

In the discharge cycle for an alkaline battery, the voltage initially decreases rapidly. For the RKN t2 container this can mean that the voltage decreases from 12 V to 10.5 V during the first few hours of operation (see example in **Fig. 6**). This is normal and no action is required.

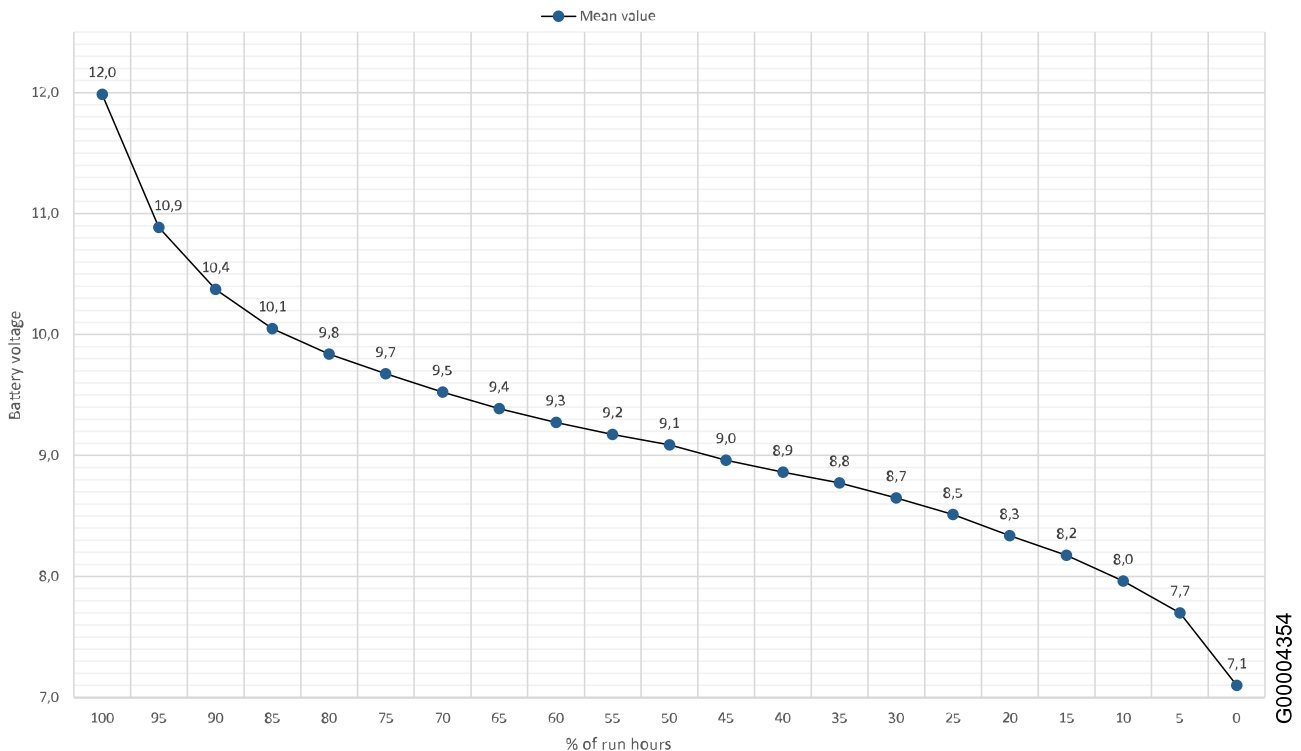

Fig. 6 Graph of battery discharge cycle over time, in battery test case with fans constantly running

G00004354

4. USING THE CONTAINER

A shipment (B) is defined as all land and air transportation that is required to transfer a loaded container from the shipper site (A) to the consignee site (C).

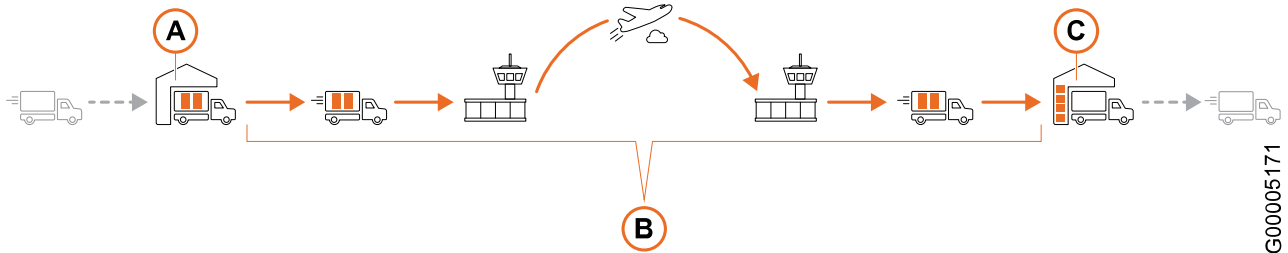

Fig. 7 The shipment

Chapters **4.1-4.3** contain three separate checklists, listing the actions to be performed when preparing a shipment, shipping the container, and finishing the shipment. Follow the applicable checklist, as defined below, to make sure that all necessary measures for a successful shipment are taken. The checklists contain references to relevant operating instructions.

- *Preparing a shipment:* Container handling at the shipper site, from receiving the empty container to handover of the loaded container.
- *Shipping:* Container handling during land transportation to and from the airport, and at the airport. To be performed by forwarders and airport personnel.
- *Finishing a shipment:* Container handling at the consignee site, from receiving the loaded container to handover of the empty container.

The checklists may be printed out to make sure that they are completed.

4.1 PREPARING A SHIPMENT

Before the shipment, the following must be performed:

- Pre-condition the cargo. Refer to **4.4.4.1 Pre-condition the cargo.**
- Pre-condition the container. Refer to **4.4.4.2 Pre-condition the container.**
- Perform the following according to **4.4.6 Loading cargo:**
 - Load and strap the cargo and, for deep frozen products, the dry ice (on top of the cargo).
 - If applicable, move the container from the temperature controlled area.
 - If the container was pre-conditioned in a temperature controlled area:
 - Install batteries and check the battery voltage.
 - Set the temperature.
 - Load dry ice into the dry ice bunker.
 - If the container was pre-conditioned using dry ice: Replace the batteries and check the battery voltage.
 - Confirm that all doors and covers are closed and latched. If required, seal the control unit.
 - Place any shipping documents or check sheets in the container document pouch.
- Confirm that the set temp is correct. Refer to **4.4.10 Operating the control unit.**
- Allow the container temperature to stabilize around the set temperature for about one hour.
- Confirm (on the control unit) that the container is within the required temperature range.
- Make sure that no alert or alarm is activated. Refer to **4.4.10.6 View activated alerts and alarms.**
- Make sure that the container is not wrapped or covered. Refer to **4.4.7 Handling the container during shipment.**
- Handle and store the container in an environment where the ambient temperature is within specified limitations. Refer to **3.7 Operating conditions.**

 **CAUTION!**

Do not use the ambient temperature displayed on the control unit as a reference for verifying ambient temperature conditions. The ambient temperature sensor is placed close to the dry ice bunker, which may affect the temperature readings, especially when the dry ice bunker is full.

For instructions on moving the container, refer to **4.4.1 Lifting and moving the container.**

For instructions on temperature recording, refer to **4.4.5 Recording temperatures.**

4.2 SHIPPING

During the shipment, the following must be performed:

- Make sure to observe all shipping precautions. Refer to **4.4.7 Handling the container during shipment.**
- Handle the container in an environment where the ambient temperature is within specified limitations. Refer to **3.7 Operating conditions.**
- Make sure that no alert or alarm is activated. Refer to **4.4.10.6 View activated alerts and alarms.**
- Change the batteries when the voltage reaches 9 V and below. Refer to **4.4.2 Mounting or removing batteries.**
- If required, perform re-icing. Refer to **4.4.7.3 Re-icing the container.**
- Make sure that all doors and covers are closed and latched.
- Limit the time on the tarmac during aircraft loading (to avoid temperature extremes and weather conditions).

For instructions on moving the container, refer to **4.4.1 Lifting and moving the container.**

4.3 FINISHING A SHIPMENT

After the shipment, the following must be performed:

- Unload the cargo. Refer to **4.4.8 Unloading the container.**
- Remove the batteries from the control unit. Refer to **4.4.2 Mounting or removing batteries.**
- Remove any remaining dry ice. Refer to **4.4.8 Unloading the container.**
- Close all doors and covers.

For instructions on moving the container, refer to **4.4.1 Lifting and moving the container.**

For storage instructions, refer to **4.4.9 Storing the container.**

4.4 OPERATING INSTRUCTIONS

4.4.1 LIFTING AND MOVING THE CONTAINER

⚠ CAUTION!
Risk of container damage! Do not push or drag the container against the ground, or attach any kind of pulling device to the door locks - they are not designed to withstand the weight of the container.

Fig. 8

G00005353

⚠ CAUTION!
Risk of container damage! The container is prone to tilting when lifted with forklift, as the center of gravity is offset due to the weight of the ice bunker. Be careful when lifting and putting down the container.

The container can be moved with forklift or roller bed system when empty or loaded.

4.4.1.1 USING FORKLIFT

1. Make sure that all doors and covers are closed.
2. Move the container using the forklift pockets in the container base.

4.4.1.2 USING A ROLLER BED SYSTEM

1. Make sure that all doors and covers are closed, or, if the doors must be open while moving the container, secure the doors in open position using the door straps.

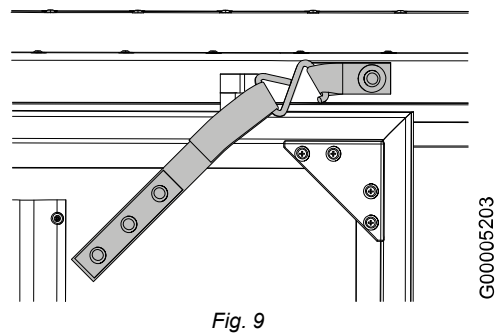

2. Steer the container on the roller bed system using the straps on the outside corners.

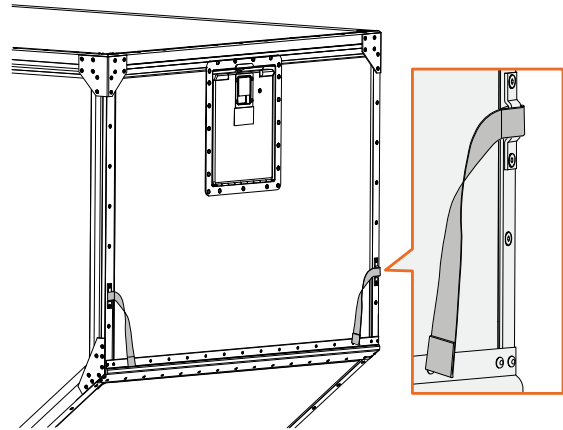

Fig. 10

4.4.2 MOUNTING OR REMOVING BATTERIES

⚠ WARNING!

Fire hazard. Do not insert lithium-ion batteries into the control unit.

ℹ NOTE!

The current set temperature is stored in the control unit memory during battery change.

1. Open the covers of the control unit.

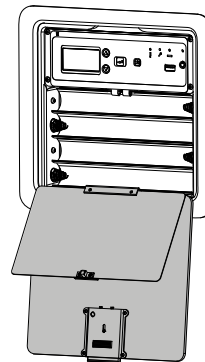

G00005120

Fig. 11



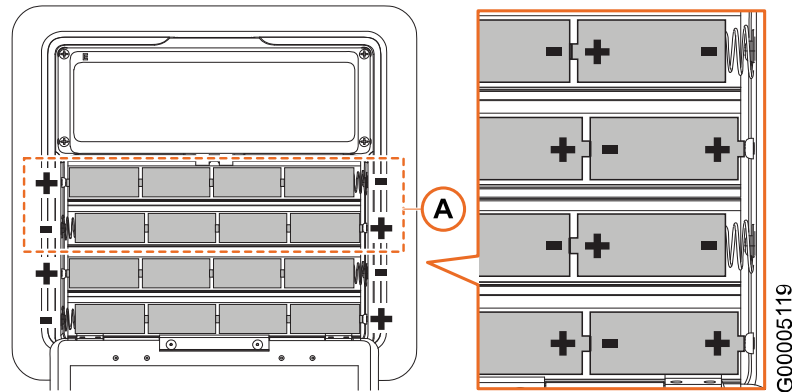

Fig. 12

2. Place 16 D-cell alkaline batteries in the holder, ensuring proper battery polarity.

Battery characteristics:

- Voltage: **1.5V**
- IEC / JIS: **LR 20**
- ANSI / NEDA: **13A**

i NOTE!

For pre-conditioning using dry ice, 8 batteries are sufficient. Place the batteries in the upper battery compartment (A).

i NOTE!

Make sure to use batteries with high capacity. For more information, refer to [3.8 Battery duration](#).

i NOTE!

For containers with SW 3.5 or later, always install 16 batteries at the same time. Otherwise the voltage display will be locked to 12 V for 10 minutes.

3. When removing used batteries, follow local regulations for disposal.

4.4.3 HANDLING DRY ICE

4.4.3.1 SAFETY PRECAUTIONS

 **WARNING!**

The dry ice used as refrigerant is considered a Class 9 dangerous cargo with the UN identification number 1845 and is described as “Carbon Dioxide, Solid”.

 **WARNING!**

Risk of suffocation! Dry ice sublimates into large amounts of CO₂ gas. This colorless, odorless gas is heavier than air and can accumulate and displace oxygen in low areas. Do not enter areas where CO₂ may have accumulated without first ventilating the space. When handling dry ice, work as fast as possible, and do not work alone.

 **WARNING!**

Risk of severe frost bite! Do not allow contact between dry ice and skin or eyes. Dry ice is extremely cold (-78.5 °C (-109 °F)), and severe frostbite can occur within seconds. Always wear gloves or other insulating material when handling dry ice.

4.4.3.2 DRY ICE BEST PRACTICES

- Calculate the required dry ice amount using the online dry ice calculation tool in the Envirotainer Portal: portal.envirotainer.com, or according to instructions in **6. Calculating dry ice amounts**.
- Use the calculated amount of dry ice. Simply filling the dry ice bunker with as much dry ice as possible may cause over-cooling, while not using all of the calculated dry ice will lead to poor cooling capacity.
- Use fresh dry ice, as moisture that condenses and freezes on the surface of the dry ice over time causes a barrier that reduces the cooling effect. Old dry ice has a shiny appearance.
- Use wrapped or unwrapped dry ice according to specifications in the online dry ice calculation tool or **4.4.3.3 Using wrapped or unwrapped dry ice**. Using unwrapped dry ice instead of wrapped, or using too thin wrapping, may cause over-cooling, while using wrapped dry ice instead of unwrapped will lead to poor cooling capacity.
- Distribute the dry ice evenly in the dry ice bunker to ensure efficient operation.
- Preferably use 5 kg dry ice blocks (2-7 kg is acceptable), as they sublime at a slower rate than smaller blocks. Gather smaller blocks together to create an approximate 5 kg bundle. When large amounts of dry ice is required, it may be necessary to use dry ice blocks of different sizes in order to fit all of the dry ice into the dry ice bunker.
- Preferably do not use dry ice pellets as a substitute for dry ice blocks. If dry ice pellets must be used, distribute the pellets in paper or plastic bags (5 kg per bag) and place the bags in the dry ice bunker.
- Depending on the size and type (wrapped/unwrapped) of dry ice used, it is not always possible to load the entire calculated amount of dry ice into the dry ice bunker. If the required amount of dry ice exceeds the dry ice bunker capacity, or if the container will be exposed to high ambient temperatures at connection or destination, schedule re-icing. Refer to **8. Technical specification** and **4.4.7.3 Re-icing the container**.
- If there are delays, or if the container temperature is above the specified range: Re-ice the container during shipment. Refer to **4.4.7.3 Re-icing the container**.

4.4.3.3 USING WRAPPED OR UNWRAPPED DRY ICE

The type of dry ice to be used - wrapped or unwrapped - depends on the container set temperature and the ambient temperature, as defined in **Table 6**. If using the online dry ice calculation tool, follow the recommendations in the tool.

Definitions:

- **Wrapped dry ice:** Dry ice delivered in paper or plastic bags, or manually wrapped in two layers of paper. The bags or paper shall remain on when the dry ice is loaded into the container. Cardboard boxes do not count as wrapping and may not be placed in the dry ice bunker.
- **Unwrapped dry ice:** Dry ice without any wrapping. Paper or plastic bags, cardboard boxes etcetera must be removed before the dry ice is loaded into the container.

Table 6 Using wrapped or unwrapped dry ice

Set temp	Ambient temperature	Wrapped	Unwrapped
+5 °C	+10 to +20 °C (+50 to +68 °F)	X	
	+20 to +30 °C (+68 to +86 °F)		X
-20 °C	Any		X

4.4.4 PRE-CONDITIONING CARGO AND CONTAINER

 **CAUTION!**

If pre-conditioning of cargo and container is not carried out correctly, the required cargo temperature may not be reached, and there is a large risk of temperature deviations during the shipment.

The container is designed to maintain the temperature of the cargo. Before cargo loading, the cargo must be pre-conditioned to the container set temperature, and the container must be pre-conditioned for at least one hour.

4.4.4.1 PRE-CONDITION THE CARGO

Pre-condition the cargo including all packing materials to the required transport temperature for at least one week before loading.

4.4.4.2 PRE-CONDITION THE CONTAINER

There are two methods for pre-conditioning the container:

- Using a temperature controlled area
- Using dry ice

4.4.4.2.1 USING A TEMPERATURE CONTROLLED AREA

1. Put 16 batteries in the control unit and check the battery voltage. Refer to **4.4.2 Mounting or removing batteries** and **4.4.10.5 Check the battery voltage**.
2. Perform a functional test. Refer to **4.4.10.8 Perform functional test**.
3. Switch off the control unit (to save battery power for the shipment). Refer to **4.4.10.2 Switch the control unit on/off**.
4. Place the container in a temperature controlled area holding the required set temperature.
5. Open the doors to the cargo space and allow at least one hour for pre-conditioning.

4.4.4.2.2 USING DRY ICE

 **WARNING!**

The dry ice used as refrigerant is considered a Class 9 dangerous cargo with the UN identification number 1845 and is described as “Carbon Dioxide, Solid”. Follow the safety precautions in **4.4.3 Handling dry ice**.

1. Calculate the amount of dry ice required for pre-conditioning and shipment using the online dry ice calculation tool in the Envirotainer Portal: portal.envirotainer.com. Make sure to take exposure to extreme heat or direct sunshine into account.

 **NOTE!**

The dry ice calculation can also be performed manually according to **6. Calculating dry ice amounts**.

→

2. Check whether to use wrapped or unwrapped dry ice. Refer to the online dry ice calculation tool or, if performing manual calculations, to **4.4.3.3 Using wrapped or unwrapped dry ice**.
3. Put 8 batteries in the upper battery compartment of the control unit and check the battery voltage. Refer to **4.4.2 Mounting or removing batteries** and **4.4.10.5 Check the battery voltage**.
4. Perform a functional test. Refer to **4.4.10.8 Perform functional test**.
5. Set the desired container temperature. Refer to **4.4.10.4 Set the temperature**.
6. Unlatch and open the dry ice bunker lid. Remove any empty wrappings from the dry ice bunker.

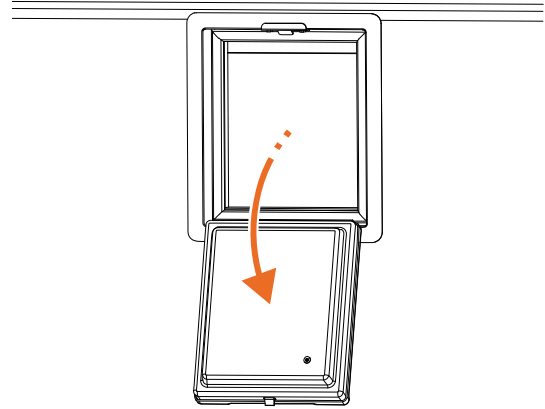

Fig. 13

G00005124

7. Distribute dry ice evenly in the dry ice bunker, following the guidelines and safety precautions in **4.4.3 Handling dry ice**:
 - For refrigerated and “do not freeze” cargo: Place all of the required dry ice in the dry ice bunker.
 - For deep frozen cargo: Place 20% of the required dry ice in the dry ice bunker. (The remaining 80% will be loaded with the cargo later.)

NOTE!

If the required amount of dry ice exceeds the dry ice bunker capacity, schedule re-icing. Refer to **4.4.7.3 Re-icing the container**.

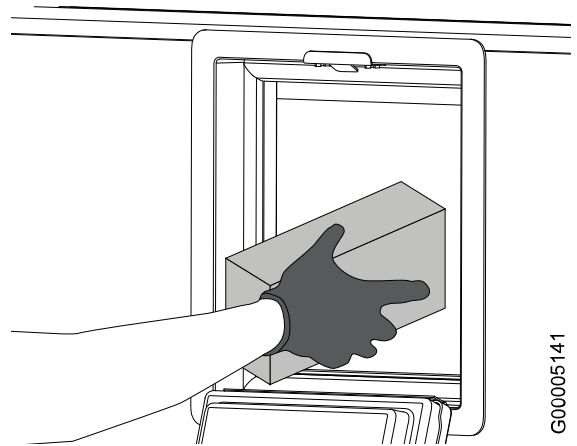

Fig. 14

G00005141

→

8. Close and secure the dry ice bunker lid.

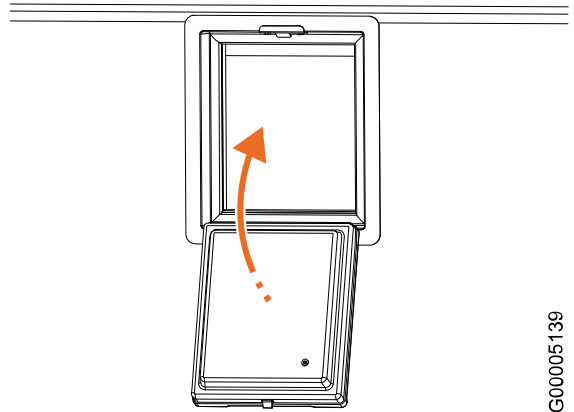

Fig. 15

G00005139

9. Close the doors to the cargo space and allow one hour for pre-conditioning, then proceed to cargo loading regardless of the container temperature.



CAUTION!

If the pre-conditioning is prolonged, some of the dry ice intended for shipment may be consumed. Before shipment, top up the dry ice bunker with 4 kg of dry ice per hour of delay to make sure that the container's cooling capability during shipment is not affected.

4.4.5 RECORDING TEMPERATURES

4.4.5.1 CARGO TEMPERATURE

1. If cargo temperature records must be kept, preferably place temperature data loggers inside the cargo boxes.



NOTE!

The temperature displayed on the control unit is the average air temperature in the container. The air temperature fluctuates more than the actual temperature of the cargo.

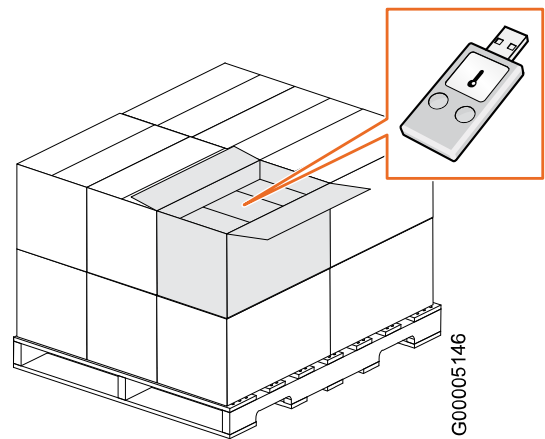

Fig. 16

G00005146

4.4.5.2 AMBIENT TEMPERATURE

1. If ambient temperature records must be kept, place a temperature data logger in the container document pouch.

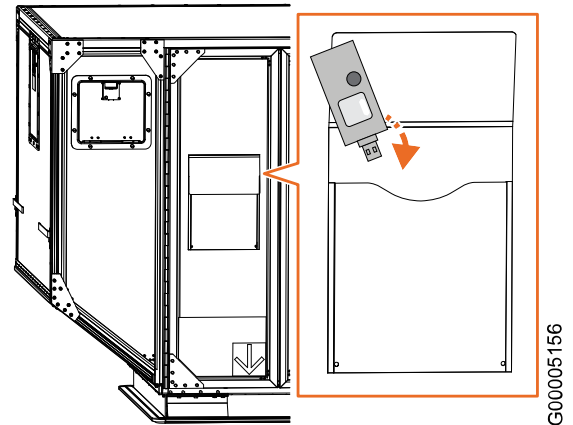

Fig. 17

4.4.6 LOADING CARGO

⚠ WARNING!

The dry ice used as refrigerant is considered a Class 9 dangerous cargo with the UN identification number 1845 and is described as “Carbon Dioxide, Solid”. Follow the safety precautions in **4.4.3 Handling dry ice**.

Load the cargo in a temperature controlled area. If this is not possible, minimize the time the container doors are open.

1. If the container has been pre-conditioned using a temperature controlled area:
 - 1a. Calculate the amount of dry ice required for the shipment using the online dry ice calculation tool in the Envirotainer Portal: portal.envirotainer.com. Make sure to take exposure to extreme heat or direct sunshine into account.

ℹ NOTE!

The dry ice calculation can also be performed manually according to **6. Calculating dry ice amounts**.

- 1b. Check whether to use wrapped or unwrapped dry ice. Refer to the online dry ice calculation tool or, if performing manual calculations, to **4.4.3.3 Using wrapped or unwrapped dry ice**.
2. Make sure that the cargo and container have been properly pre-conditioned. Refer to **4.4.4 Pre-conditioning cargo and container**.

ℹ NOTE!

As the lower temperature range for the sensor is -45 °C (-49 °F), the display may show odd temperatures if the current temperature in the cargo space is below -45 °C (-49 °F).

⚠ CAUTION!

If the cargo is wrapped, make sure that the pallet base is not covered, as this would obstruct the airflow along the floor beneath the cargo.

Load the cargo onto a pallet to allow proper airflow underneath the cargo. Make sure to distribute the cargo weight evenly on the pallet. If the cargo shall be hand loaded into the container, put the pallet on the container floor and load the cargo on the pallet.

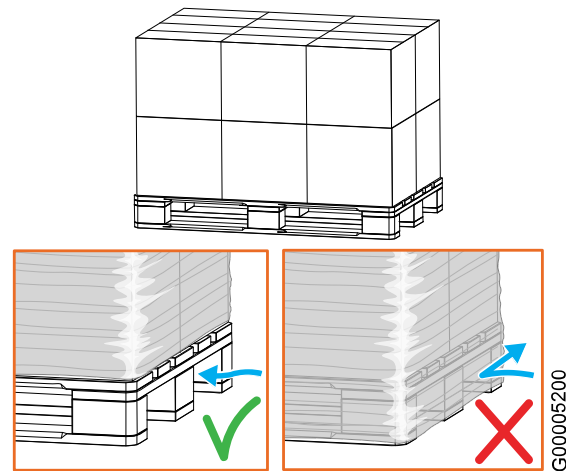
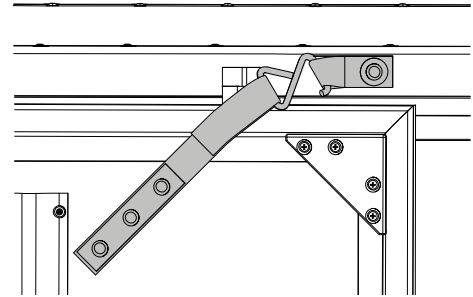

Fig. 18



4. Open the doors to the cargo space and lock them in open position using the door straps.



G00005203

Fig. 19

5. For deep frozen cargo only: Distribute 80% of the required dry ice on top of the cargo using one of the following methods, and following the guidelines and safety precautions in **4.4.3 Handling dry ice**:

- Put the dry ice in boxes (A) and secure it on top of the cargo with plastic wrap or similar or
- Distribute the dry ice on top of the cargo (B) and secure it with plastic wrap or similar.

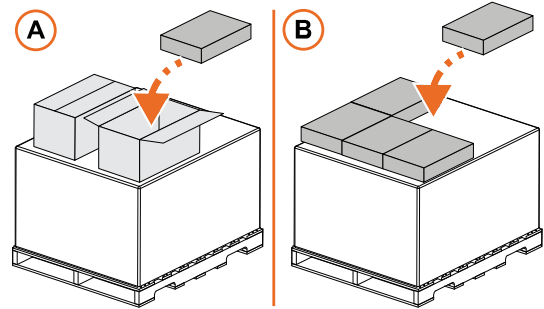

G00005127

Fig. 20

NOTE!

Make sure that the maximum loading height is not exceeded. For dimensions, refer to **8. Technical specification**. Put any remaining dry ice (of the 80%) in boxes, to be placed around the cargo later.

CAUTION!

Do not secure the straps to the spacers on the container walls, as there is a risk of damaging the spacers.

As it may be hard to reach the inner tie-down brackets with the cargo in place, consider fastening the tie-down studs and straps to the tie-down brackets and temporarily placing the straps over the container roof before loading the cargo.

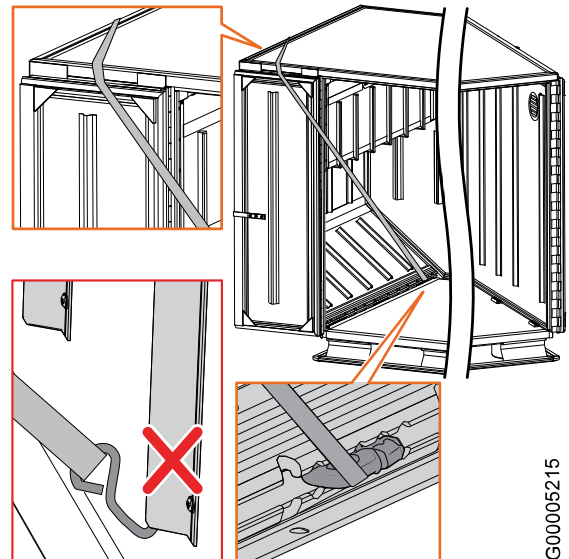

G00005215

Fig. 21



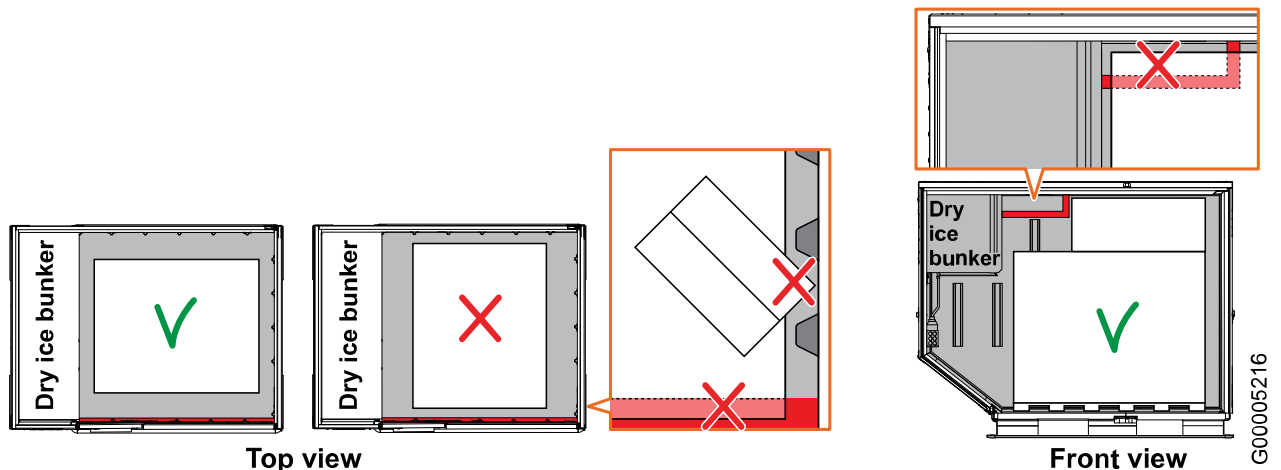

Fig. 22

7. **CAUTION!**
 Make sure that the cargo does not block the airflow between the spacers or in front of the fans. Red markings on the container floor, walls and the dry ice bunker indicates where cargo may not be placed.

Load the cargo pallets into the pre-conditioned container.

Make sure of a proper airflow around the cargo, and distribute the cargo weight evenly. Refer to **Fig. 22** for correct placement of cargo.

8. For deep frozen cargo only: Distribute any remaining boxes of dry ice on and around the cargo.

9. **CAUTION!**
 Cargo that is not properly strapped may shift and obstruct the air flow, causing temperature deviations as well as cargo and container damage.

Secure the cargo and, if applicable, the dry ice boxes, to the tie-down brackets in the cargo space using straps (**Fig. 21**).

10. Close and lock the doors. If applicable, secure the door lock of the right hand door with a security seal.

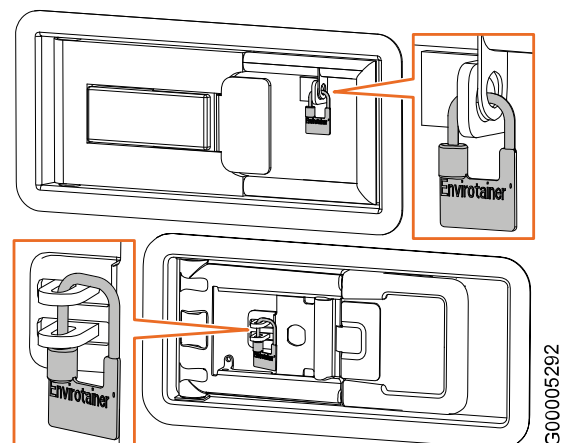

Fig. 23 Correct placement of security seal depending on door lock model (two models available).



- 11. If applicable, move the container from the temperature controlled area. Refer to **4.4.1 Lifting and moving the container**.
- 12. If the container was pre-conditioned using a temperature controlled area:
 - 12a. Switch on the control unit.
 - 12b. Check the battery voltage. Refer to **4.4.10 Operating the control unit**.
 - 12c. Set the temperature. Refer to **4.4.10 Operating the control unit**.
 - 12d. Unlatch and open the dry ice bunker lid. Remove any empty wrappings from the dry ice bunker.

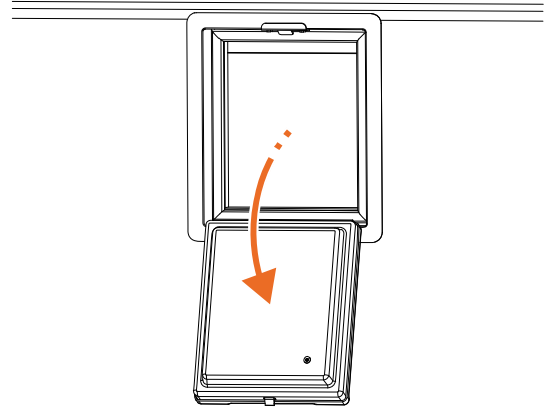

Fig. 24

G00005124

12e. Load dry ice into the dry ice bunker, following the guidelines and safety precautions in **4.4.3 Handling dry ice**:

- For refrigerated and “do not freeze” cargo: Place all of the required dry ice in the dry ice bunker.
- For deep frozen cargo: Place the remaining 20% of dry ice in the dry ice bunker.



NOTE!

If the required amount of dry ice exceeds the dry ice bunker capacity, schedule re-icing. Refer to **4.4.7.3 Re-icing the container**.

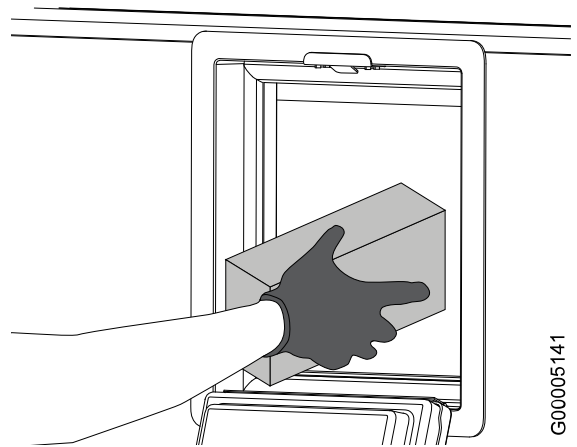

Fig. 25

G00005141

12f. Close and secure the dry ice bunker lid.

12g. Proceed to step **14**.

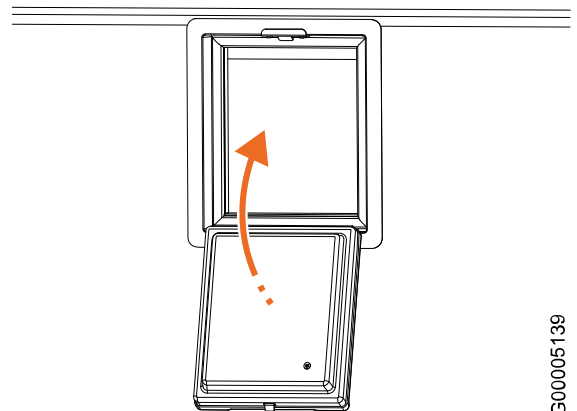

Fig. 26

G00005139



13. If the container was pre-conditioned using dry ice:
 - 13a. Remove the batteries used for pre-conditioning, and insert 16 new batteries into the control unit. Refer to **4.4.2 Mounting or removing batteries**.
 - 13b. Check the battery voltage and make sure that the set temperature is correct. Refer to **4.4.10 Operating the control unit**.
14. Place any shipping documents or check sheets in the container document pouch.

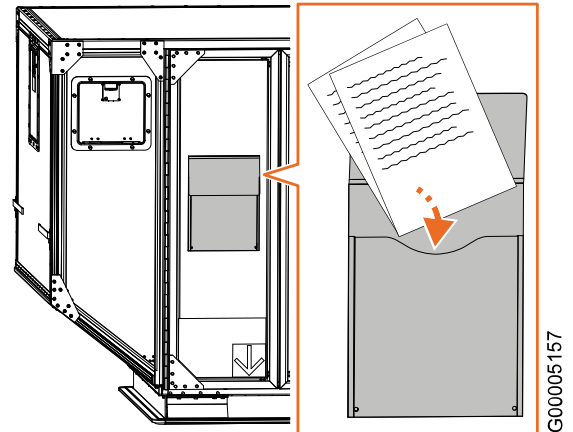

Fig. 27

15. Optional: Seal the control unit with a security seal inserted through the slot in the latch. For security seal properties, refer to **3.4 Attachment points for security seals**.

To view information on the display after sealing the control unit, refer to **4.4.10.9 View information on a sealed control unit**.

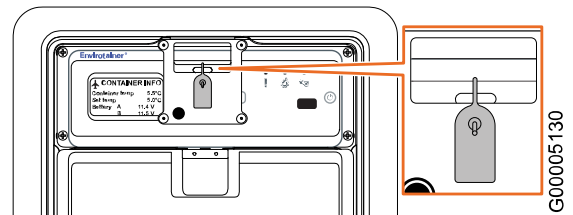

Fig. 28

i NOTE!

If the control unit is sealed, the battery compartment is sealed as well, and the seal must be broken for battery replacements.

16. Allow up to one hour for the container temperature to stabilize around the set temperature.

4.4.7 HANDLING THE CONTAINER DURING SHIPMENT

4.4.7.1 SHIPPING PRECAUTIONS

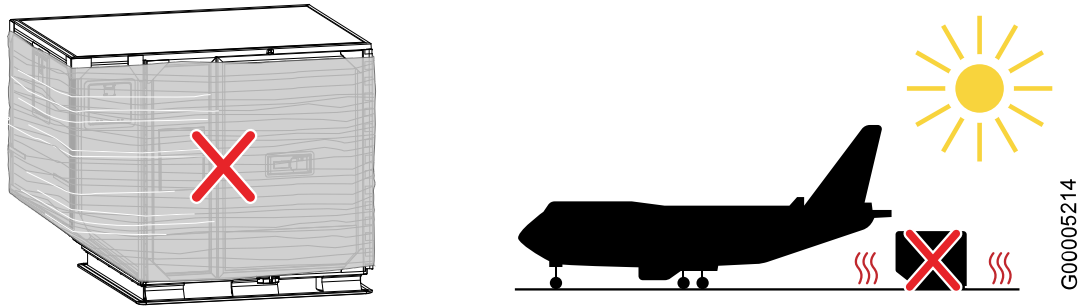

Fig. 29 General shipping precautions

G00005214

⚠ CAUTION!
Do not wrap or cover the container. If the container is wrapped or covered, the air inlets and outlets are blocked and the container cannot operate.

⚠ CAUTION!
Limit the time on the tarmac during aircraft loading, to avoid temperature extremes and weather conditions.

4.4.7.2 GENERAL HANDLING RECOMMENDATIONS

- Make sure that the shipper complies with airline regulations for shipping dry ice.
- Store and transport the container in an environment where the ambient temperatures are within the recommended range. Refer to **3.7 Operating conditions**.
- Replace the batteries when the voltage reaches 9 V and below. Refer to **4.4.2 Mounting or removing batteries**.
- If delays occur during transit, consider re-icing the container. Refer to **4.4.7.3 Re-icing the container**.
- For refrigerated and “do not freeze” cargo:
 - If a temperature controlled truck is used, it is recommended to set the temperature of the truck 10 °C (18 °F) higher than the set temperature of the container.
 - Provide Notice to Captain (NOTOC) and note on the Air Way Bill: *“Maintain 15-20 °C aircraft cargo hold. Do not position container near the cargo door.”*

4.4.7.3 RE-ICING THE CONTAINER

⚠ WARNING!
The dry ice used as refrigerant is considered a Class 9 dangerous cargo with the UN identification number 1845 and is described as “Carbon Dioxide, Solid”. Follow the safety precautions in **4.4.3 Handling dry ice**.

If the required amount of dry ice exceeds the dry ice bunker capacity, or if there is a delay, it may be necessary to re-ice the container. The new dry ice shall be added to the remaining dry ice (top up). There are two types of re-icing:

→

- Scheduled: Used when the required amount of dry ice exceeds the dry ice bunker capacity. Scheduled re-icing is calculated in the online dry ice calculation tool in the Envirotainer Portal: portal.envirotainer.com.
- Unscheduled: Used when there is an unplanned delay. The online dry ice calculation tool states the amount of dry ice to be used for every 24 hour delay.

NOTE!

Authorization from the shipper is required to open the container doors.

1. Note the required amount of dry ice to be added according to the existing dry ice calculation.
2. Load dry ice, following the guidelines and safety precautions in **4.4.3 Handling dry ice**:
 - For refrigerated cargo: Place all of the required dry ice in the dry ice bunker.
 - For deep frozen cargo: Place 20 % of the required dry ice in the dry ice bunker and 80 % on top of the cargo. If opening the container doors is not authorized by the shipper, place all of the dry ice in the dry ice bunker.
3. If required, place the container in a cooler area.

4.4.8 UNLOADING THE CONTAINER

WARNING!

The dry ice used as refrigerant is considered a Class 9 dangerous cargo with the UN identification number 1845 and is described as “Carbon Dioxide, Solid”. Follow the safety precautions in **4.4.3 Handling dry ice**.

1. Unload the cargo.

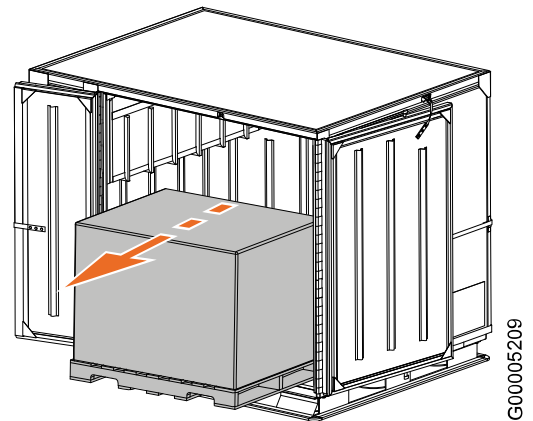

Fig. 30

G00005209

2. Remove the batteries. Refer to **4.4.2 Mounting or removing batteries**.



- 3. Remove and dispose of any remaining dry ice in the dry ice bunker. If local regulations allow it, the dry ice may be placed outdoors, where it will dissolve quickly.

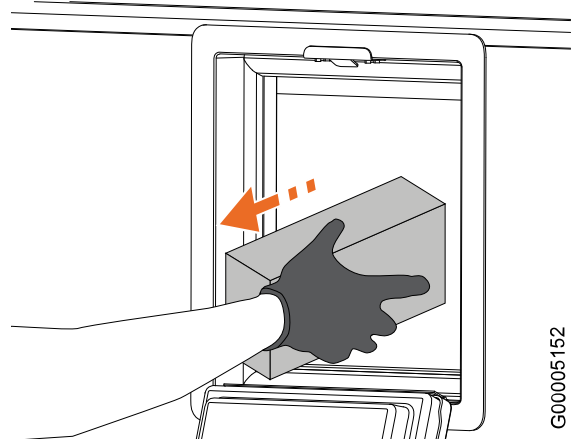

Fig. 31

G00005152

- 4. Close all doors, lids and covers.

4.4.9 STORING THE CONTAINER

CAUTION!

Do not store any containers, cargo or other items on top of the container.

Minimum storage requirements:

- **Placement:** On flat ground (to make sure that water will not collect in or around the container).
- **Ambient temperature:** -40 °C to +50 °C (-40 °F to +122 °F).

If possible, store the container indoors away from direct sunlight.

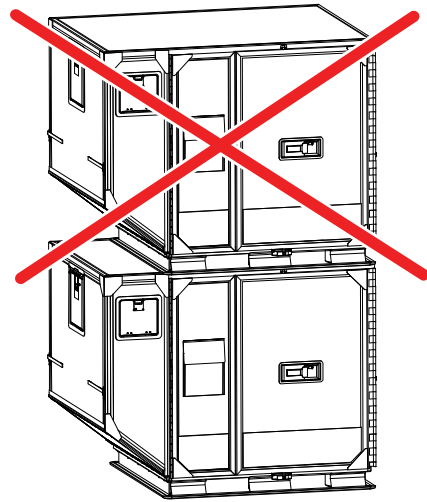

Fig. 32

G00005212

4.4.10 OPERATING THE CONTROL UNIT

4.4.10.1 THE CONTROL UNIT

The control unit is the user interface for operating the container.

The default mode when the display is switched on is **CONTAINER INFO**. If there are any messages, for instance alerts or alarms, the display toggles between default mode and the message.

In default mode, the display enters sleep mode 20 seconds after the last interaction. To wake the display from sleep mode, refer to **4.4.10.3 Wake display from sleep mode**.

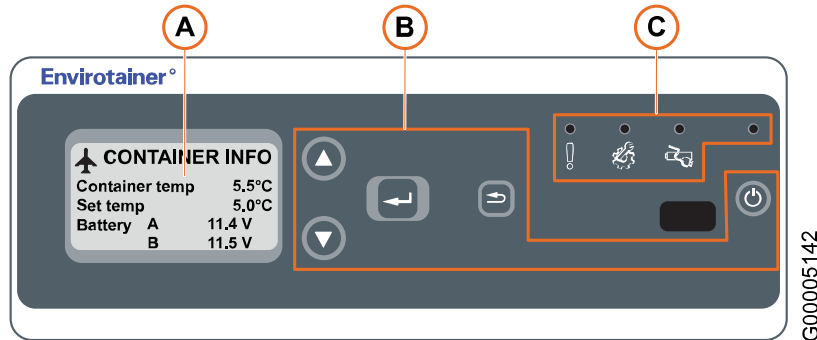

Fig. 33 The control unit

Table 7 Control unit features

Pos	Description
A	Display, refer to Table 8
B	Buttons, refer to Table 10
C	Indicator lights, refer to Table 11

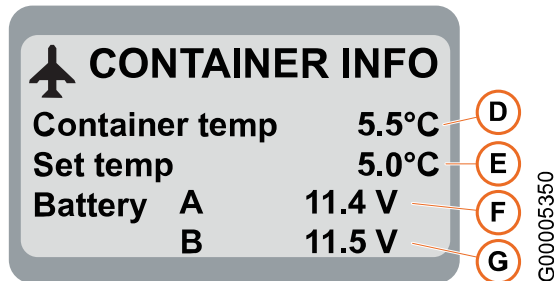

Fig. 34 Display (default mode)

Table 8 Display (default mode)

Pos	Description
D	Current temperature in the cargo space (°C or °F depending on setting)
E	Current set temperature (°C or °F depending on setting)
F	Current battery voltage*, upper battery pack
G	Current battery voltage*, lower battery pack

*The battery voltage on the display differs depending on the container's software. Refer to **Table 9**



Table 9 Voltage display differences depending on SW

Difference	Container SW ≤ 3.4	Container SW ≥ 3.5
Voltage display principal	Fluctuating with power consumption	Decreasing according to lowest measured voltage value
During operation	Random between 12 to 7 V	Decreasing from 12 to 7 V
Update frequency	Every 5 seconds	Every 5 seconds
When batteries are removed	Display shows “-.-”	Display decreases to “-.-”
When new batteries have been inserted	Random between 12 to 7 V	Locked to 12 V for up to 10 minutes

Table 10 Buttons













Button	Description	Button	Description
	ON/FF: Switch the control unit on/off		UP: Step upwards in the menu
	MENU/ENTER: <ul style="list-style-type: none"> Enter menus Confirm changes 		DOWN: Step downwards in the menu
	BACK: Return to previous menu		

Table 11 Indicator lights

Light	Description
	SYSTEM INDICATOR (green light): Steady light: The container system is powered on
 	CHARGING INDICATOR (blue light): Not used for t-tech containers, and only lights up for a few seconds with the other indicator lights when the container is started up
 	ALERT INDICATOR (yellow light): Flashing light: There is an active alert
 	ALARM INDICATOR (red light): Flashing light: There is an active alarm

MENU STRUCTURE

The control unit has the following menu structure, starting from the default mode:

TEMP MENU	SET TEMP	Set the “set temp”
	CONTAINER TEMP	Show the container temperature
	AMBIENT TEMP	Show the ambient temperature
	TEMP UNIT	Set the temperature unit (°F or °C)

→

SYSTEM MENU	ALARM VIEW	Show alarms
	ALERT VIEW	Show alerts
	FAN SPEED*	Show the rpm of the fan
	FAN STATUS	Show the fan status
	TIME & DATE	Show the time and date
	SW REVISION	Show the software revision
	SYSTEM INFO	Show system information: –IATA-code –Serial number of display unit –Part number of the display unit
SETUP	Only for Envirotainer use, login required	

*FAN SPEED is only available on containers with SW 3.5 or later.

NOTE!

The display value for the fan speed may fluctuate, this has to do with the measurement method and not that the fan has an instantaneous fluctuating speed. Since the speed of the fan has a linear relationship with the voltage on the batteries, the speed of the fan will decrease when the voltage on the batteries decreases. This is considered normal behavior for the fan.

4.4.10.2 SWITCH THE CONTROL UNIT ON/OFF

Switch the control unit on:

1. Press .

During start-up, the display shows **System On**, and the four indicator lights are lit one by one (yellow-red-blue-green) for function testing purposes. If the indicator lights are not lit during start-up, refer to **5. Troubleshooting**.

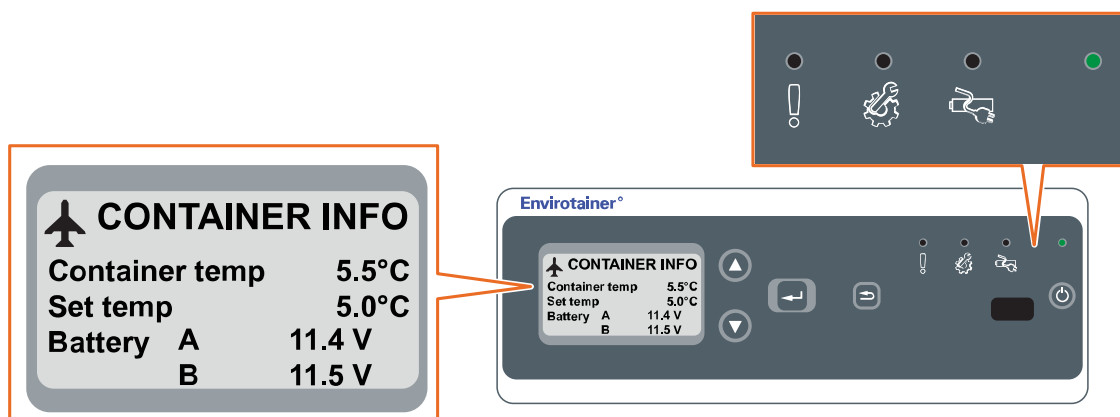



Fig. 35

2. Make sure that all indicator lights except the system indicator (green light) turn off after one second, and that the display is in default mode (showing **CONTAINER INFO**). If any alert or alarm is activated, the display toggles between default mode and showing the activated alert or alarm. Refer to **5. Troubleshooting** for possible explanation and solution.

G00005137



Switch the control unit off:

1. Press  and hold for three (3) seconds.

4.4.10.3 WAKE DISPLAY FROM SLEEP MODE



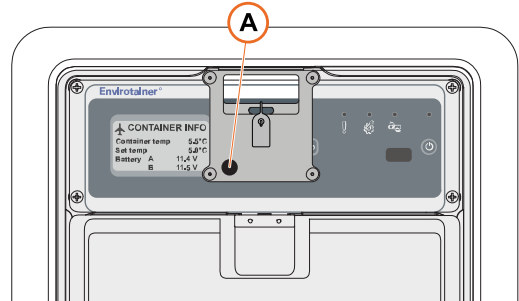





1. Press the info button (A) or, if the lid is open, .



G00005140





Fig. 36

4.4.10.4 SET THE TEMPERATURE

1. If applicable, change unit between Celsius and Fahrenheit:
 - 1a. Press . The display shows **TEMP MENU**.
 - 1b. Press . The display shows **SET TEMP**.
 - 1c. Press  or  to change between Celsius (**Current unit C Set changes to F**) and Fahrenheit (**Current unit F Set changes to C**), depending on the current setting.
 - 1d. Press  until back in default mode.
2. Press . The display shows **TEMP MENU**.
3. Press . The display shows **SET TEMP**.
4. Press . The display shows **SET NEW TEMP**.

 **NOTE!**

The **SET NEW TEMP** mode is activated for 30 seconds. If the display returns to default mode before a new set temperature has been confirmed by pressing , the new set temperature is not saved.

5. Use  and  to change the container set temperature (with increments of 0.5 °C). Hold down the buttons to speed up the change.
6. Press  to confirm the new set temperature.
7. Press  until back in default mode.
8. Confirm that the container set temperature is correct.

4.4.10.5 CHECK THE BATTERY VOLTAGE

New batteries are expected have a voltage reading of at least 11 V. The fans will operate until the voltage drops to the “torpor” mode (voltage cut-off limit) set at 8.0 V. For containers equipped with software version 3.5 or later, this limit is lowered to 7.1 V.

→

1. Make sure the control unit is on and the display is not in sleep mode. Refer to **4.4.10.2 Switch the control unit on/off** and **4.4.10.3 Wake display from sleep mode**.

2. Check the battery voltage for the two battery packs on the control unit display. Battery A is the upper battery pack and battery B is the lower battery pack.

Change the batteries if necessary, refer to **4.4.2 Mounting or removing batteries**.

NOTE!
If the battery voltage is above 15 V, the control unit is malfunctioning. Refer to **5. Troubleshooting**.

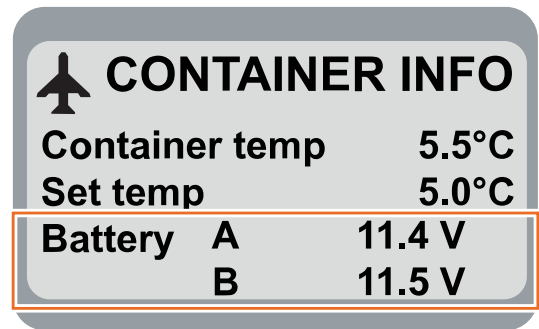

Fig. 37

G00005138

4.4.10.6 VIEW ACTIVATED ALERTS AND ALARMS

If the red or yellow indicator light on the control unit is flashing, an alert (yellow) or alarm (red) has been activated. The display toggles between default mode and showing the alert or alarm text, but it is also possible to view the alert or alarm text in the control unit menu.

- Press **ESC**. The display shows **TEMP MENU**.
- Use **▲** or **▼** to step to **SYSTEM MENU** and press **ESC** to confirm. The display shows **ALARM VIEW**.
- View alerts or alarms:

3a. To view alerts: Use **▲** or **▼** to step to **ALERT VIEW**, and press **ESC** to confirm. The activated alert is shown as **ALERT 1/1**, **ALERT 1/2** etc, depending on the number of activated alerts. Use **ESC** to scroll between activated alerts, and refer to **5. Troubleshooting** for explanations and possible solutions.

3b. To view alarms: Press **ESC**. The activated alarm is shown as **ALARM 1/1**, **ALARM 1/2** etc, depending on the number of activated alarms. Use **ESC** to scroll between activated alarms, and refer to **5. Troubleshooting** for explanations and possible solutions.

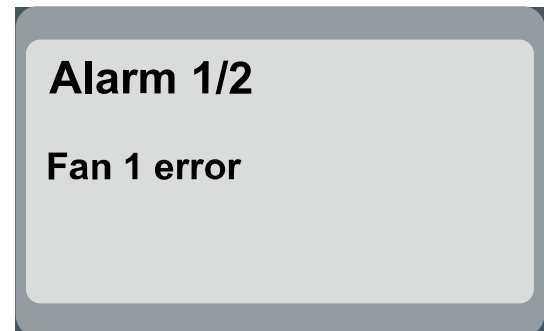



Fig. 38

4. Press **ESC** until back in default mode.

4.4.10.7 VIEW SOFTWARE REVISION

- Press **ESC**. The display shows **TEMP MENU**.
- Use **▲** or **▼** to step to **SYSTEM MENU** and press **ESC** to confirm. The display shows **ALARM VIEW**.

→

- Use  or  to step to **SW REVISION**. Note the software version.

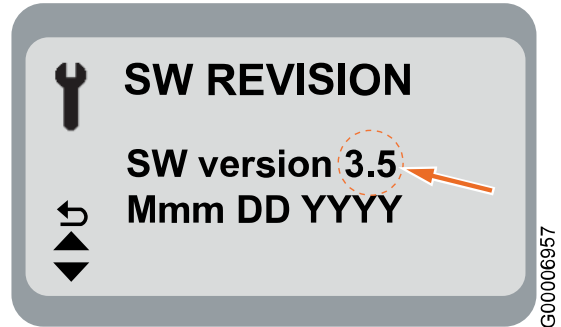

Fig. 39

4.4.10.8 PERFORM FUNCTIONAL TEST

- Set the temperature to at least 3 °C (5.4 °F) below the current container temperature. Refer to **4.4.10.4 Set the temperature**. The fan turns on.
- Make sure that air is discharged from both air guides in the container ceiling.

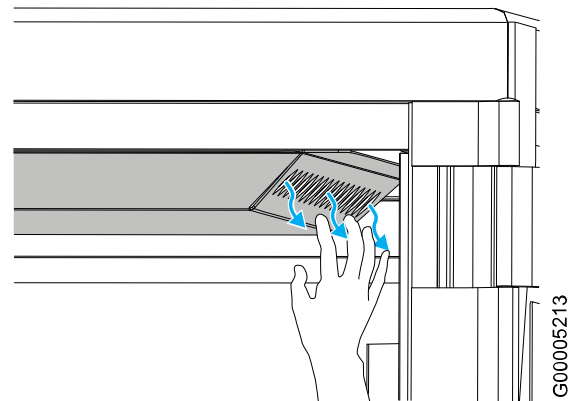

Fig. 40

- Set the temperature to at least 3 °C (5.4 °F) above the current container temperature. The fan turns off.
- Make sure that no alert (yellow) or alarm (red) indicator light is flashing. If any indicator light is flashing, an alert or alarm text (A) is shown on the display. Note the alert or alarm text and refer to **5. Troubleshooting** for an explanation and possible solutions.

It is also possible to view activated alerts and alarms in the control unit menu. Refer to **4.4.10.6 View activated alerts and alarms**.

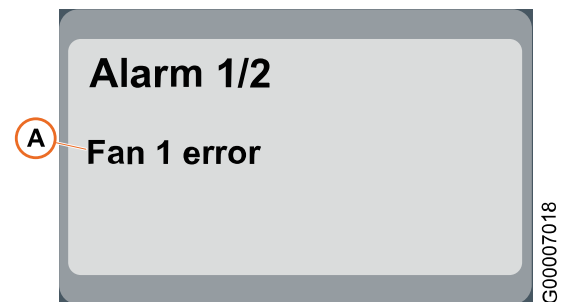

Fig. 41

4.4.10.9 VIEW INFORMATION ON A SEALED CONTROL UNIT

When the control unit has been sealed, it is still possible to view information on the display using the info button.



1. Press the info button to scroll between default mode, alarm status and alert status. The backlight illuminates for 20 seconds when the button is pressed.



NOTE!

It is only possible to toggle through the menu with the info button - no settings can be made.

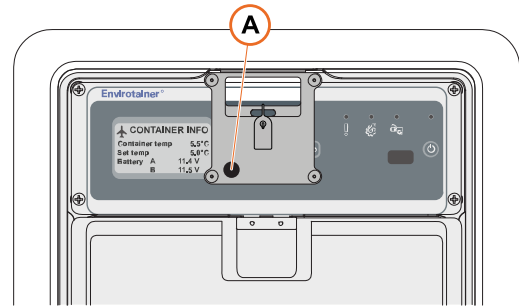

Fig. 42

G00005140

4.4.10.10 CHECK DATE OF NEXT CONTROL UNIT VERIFICATION

The control unit is verified annually. The verification is recorded with a verification sticker placed on the control unit. Next verification must be performed before the last day of the month indicated on the "due" part of the sticker.

MAINTENANCE / VERIFICATION PROGRAMME												Sign:
Performed	18	19	20	21	22	23	24	25	26	27		
	J	F	M	A	M	J	J	A	S	O	N	D
Due	18	19	20	21	22	23	24	25	26	27		
	J	F	M	A	M	J	J	A	S	O	N	D

G00004095

Fig. 43

If verification has not been performed as scheduled, please contact Envirotainer. Refer to **1.3 Contact**.

5. TROUBLESHOOTING

These troubleshooting tables can be used when the control unit indicates an alert or alarm, or when there is a problem with the container. If a solution can not be found, replace the container. Meanwhile, place the cargo in a temperature controlled area.

5.1 ALERTS

An active alert is indicated by a flashing yellow indicator light  on the control unit.

Alert	Explanation or possible cause	Solution	Reference
Change Batteries! (Fan stopped)	On containers with SW 3.5 or later: Torpor mode has been reached. The battery voltage is 7.1 V or less, and there is insufficient battery voltage to keep the fan running.	Change the batteries. The control unit will operate until the voltage is below 7.0 V.	<u>4.4.2 Mounting or removing batteries.</u>
	On containers with SW 3.4 or earlier: Torpor mode has been reached. The battery voltage is, or has been 8.0 V or less, and there is insufficient battery voltage to keep the fan running. The display shows instantaneous voltage, meaning that it differs depending on if the fan is currently running or not. (When the fan starts, the displayed voltage decreases and vice versa.)		
Battery below 8.9 V	On containers with SW 3.5 or later: The battery voltage is below 8.9 V.	Check the battery voltage immediately. Consider changing the batteries, depending on the remaining shipping time. The fan will operate until the battery voltage is below 7.1 V, and the control unit until the voltage is below 7.0 V.	<u>4.4.10.5 Check the battery voltage.</u>
	On containers with SW 3.4 or earlier: The battery voltage is below 8.9 V. The display shows instantaneous voltage, meaning that it differs depending on if the fan is currently running or not. (When the fan starts, the displayed voltage decreases and vice versa.)	Check the battery voltage immediately. Consider changing the batteries, depending on the remaining shipping time. The fan will operate until the battery voltage is below 8.0 V, and the control unit until the voltage is below 7.0 V.	

5.2 ALARMS

An active alarm is indicated by a flashing red indicator light  on the control unit.

Alarm	Explanation or possible cause	Solution	Reference
FAN 1 Error	On containers with SW 3.5 or later: The fan is out of order.	<ul style="list-style-type: none"> Replace the container. 	<u>1.3 Contact</u>
	On containers with SW 3.4 or earlier: <ul style="list-style-type: none"> If the container is used for shipment in the refrigerated or “do not freeze” temperature range: The fan is out of order. If the container is used for shipment in the “deep frozen” (set temp < -10 °C) temperature range: The fan has frozen due to moisture freezing on the fan blades due to low temperature in the cargo space. This can occur and does not put the cargo at risk. 	<ul style="list-style-type: none"> If the container is used for shipment of refrigerated and “do not freeze” cargo: Replace the container. If the container is used for shipment of deep frozen cargo: Proceed with the shipment. <div style="border: 1px solid black; padding: 5px; margin-top: 10px;"> <p> NOTE! A screwdriver or a similar tool can be used to manually rotate fan blades and get them unstuck, if they are frozen and not moving.</p> </div>	
Temp Probe Error	The temperature sensor is out of order. (The fan has turned off due to lost connection with the temperature sensor.)	Replace the container.	<u>1.3 Contact</u>

5.3 HARDWARE

Problem	Possible cause	Solution	Reference
Blank or diffuse display on the control unit	If the system indicator (green light) is lit: The display is in sleep mode.	No action is needed. The container is still operating. If required: wake the display from sleep mode.	<u>4.4.10.3 Wake display from sleep mode</u>
	Batteries are missing or depleted.	Insert or replace batteries.	<u>4.4.2 Mounting or removing batteries</u>
	The battery polarity is wrong.	Re-insert the batteries in the correct direction.	<u>4.4.2 Mounting or removing batteries</u>
	There is no contact between the batteries and connectors, due to malformed battery holder or insufficient contact spring tension.	Replace the container.	<u>1.3 Contact</u>
The control unit does not respond as expected when a button is pressed.	The control unit requires a restart.	Remove and re-insert the batteries.	<u>4.4.2 Mounting or removing batteries</u>
	The buttons are not working.	Replace the container.	<u>1.3 Contact</u>
The yellow, red or blue indicator lights do not turn off after startup of the container	An alert or alarm is active.	Read the alert or alarm text on the display. Refer to the applicable Troubleshooting chapter for possible solutions.	<u>4.4.10.6 View activated alerts and alarms</u> <u>5.1 Alerts</u> <u>5.2 Alarms</u>
The battery voltage is displayed as higher than 15 V	Wrong type of batteries is used.	Replace batteries to recommended type.	<u>8. Technical specification</u>
	The control unit is malfunctioning.	Replace the container.	<u>1.3 Contact</u>
Only valid for SW 3.5 or later: The battery voltage is displayed as 12 V for any of the battery packs	Batteries in the affected battery pack have just been replaced, display is "frozen" for 10 minutes while batteries in the other pack is replaced	Wait for at least 10 minutes, then the delay for battery change is reset	<u>4.4.10.1 The control unit</u>
		Remove and re-insert the batteries.	<u>4.4.2 Mounting or removing batteries</u>
The battery voltage is displayed as 0.1 V for any of the battery packs, even though the batteries are removed	CU is fully functional, but the tolerance of CU voltage device is higher than 0	No action is required, CU is still working as normal	<u>4.4.10.1 The control unit</u>
		Place new batteries in battery compartment and proceed as normal	<u>4.4.2 Mounting or removing batteries</u>
Only valid for SW 3.5 or later: The battery voltage is displayed with a large difference between the packs (i. e. 8.2 V and 11.5 V)	Only one of the battery packs has been replaced with new batteries.	Replace also the batteries in the pack with low voltage displayed.	<u>4.4.2 Mounting or removing batteries</u>
		Remove and re-insert the batteries.	

→

Problem	Possible cause	Solution	Reference
The fan is not working	On containers with SW 3.5 or later: If the display shows Change Batteries! (Fan stopped) : The battery voltage is 7.1 V or less.	Replace the batteries.	<u>4.4.10.5 Check the battery voltage</u>
	On containers with SW 3.4 or earlier: If the display shows Change Batteries! (Fan stopped) : The battery voltage is, or has been, 8.0 V or less.		
	The temperature in the cargo space is less than 3 °C (5.4 °F) above the set temperature (i.e. within the temperature tolerance).	Check the temperature difference between the actual cargo space temperature and the set temperature. If it is less than 3 °C (5.4 °F), reduce the set temperature and confirm that the fan turns on.	<u>4.4.10.4 Set the temperature</u>
	The control unit display is not working.	Check the solutions for “Blank or diffuse display on the control unit”.	
	If the display shows FAN 1 Error : The fan is out of order or has frozen.	Check the solutions for the applicable alarm.	<u>5.2 Alarms</u>
	If the display shows Temp Probe Error : The temperature sensor is out of order and the fan has turned off due to lost connection with the temperature sensor.	Check the solutions for the applicable alarm.	<u>5.2 Alarms</u>



Problem	Possible cause	Solution	Reference
The container temperature is too high (refrigerated cargo)	The container doors are, or have recently been, open.	Make sure that the doors are closed. Monitor the container temperature and make sure that it returns to range.	
	Cargo has just been loaded, and the cargo and/or container was not correctly pre-conditioned.	Abort the current shipment. If applicable, perform pre-conditioning again.	<u>4.4.4 Pre-conditioning cargo and container</u>
	The container is stored in a temperature that is more than 25 °C (45 °F) above the set temp.	Move the container to a cooler area (minimum temperature: 5 °C (9 °F) above the set temp).	
	The container was recently exposed to sun/high temperatures.	Monitor the container temperature. If it does not return to range, redistribute the dry ice in the dry ice bunker, or unwrap some ice.	
	The container set temp is not correct.	Adjust the set temp.	<u>4.4.10.4 Set the temperature</u>
	The unit of measure (°C or °F) is not correct.	Change the unit of measure.	<u>4.4.10.4 Set the temperature</u>
	There is not enough dry ice in the dry ice bunker.	Add dry ice according to the recommended amount for the shipment.	<u>6. Calculating dry ice amounts</u>
	Wrong type of dry ice is used (for instance wrapped instead of unwrapped, or pellets instead of blocks).	Use the recommended type of dry ice.	<u>4.4.3.3 Using wrapped or unwrapped dry ice</u>
	The control unit is malfunctioning.	Check the troubleshooting subjects regarding the control unit.	
	On containers with SW 3.5 or later: If the display shows Change Batteries! (Fan stopped) : The battery voltage is 7.1 V or less.	Replace the batteries.	<u>4.4.2 Mounting or removing batteries</u>
	On containers with SW 3.4 or earlier: If the display shows Change Batteries! (Fan stopped) : The battery voltage is, or has been, 8.0 V or less.		
If the display shows FAN 1 Error : The fan is out of order.	Replace the container.	<u>1.3 Contact</u>	

→

Problem	Possible cause	Solution	Reference
The container temperature is too low (refrigerated product)	The container is stored in a temperature that is less than 5 °C (9 °F) above the set temp.	Move the container to a warmer area, at least 5 °C (9 °F) above the set temp.	
	The container was recently exposed to temperatures that were less than 5 °C (9 °F) above the set temp.	Monitor the container temperature. If the container temperature returns to range, no action is necessary.	
	The container set temp is not correct.	Adjust the set temp. If the fans do not turn off when the set temp is increased, replace the container.	4.4.10.4 Set the temperature 1.3 Contact
	The unit of measure (°C or °F) is not correct.	Change the unit of measure.	4.4.10.4 Set the temperature
	There is too much dry ice in the dry ice bunker.	Remove some of the dry ice.	6. Calculating dry ice amounts
	Wrong type of dry ice is used (for instance unwrapped instead of wrapped blocks).	Use the recommended type of dry ice.	4.4.3.3 Using wrapped or unwrapped dry ice
	If the fan does not turn off when the set temperature is increased: the fan is malfunctioning.	Replace the container.	1.3 Contact
	The container was not correctly pre-conditioned.	Abort the current shipment. If applicable, perform pre-conditioning again.	
Unexpected container temperature shown on the display (frozen product)	The lower temperature range for the temperature sensor is -45 °C (-49 °F). The display might show odd temperatures if the current temperature in the cargo space is below -45 °C (-49 °F).	No action required.	

6. CALCULATING DRY ICE AMOUNTS

i NOTE!

Only authorized persons should perform dry ice calculations. Preferably use the online dry ice calculation tool in the Envirotainer Portal: portal.envirotainer.com. If this is for some reason not possible, perform a manual calculation according to the method described in this chapter.

The amount of dry ice to be loaded into the container is the sum of up to two different calculations:

1. Dry ice amount required for pre-conditioning. Only applicable if the container shall be preconditioned with dry ice. Refer to **6.1 Calculate dry ice amount for container pre-conditioning**.
2. Dry ice amount required for shipment. The calculation is based on the set temperature, along with the time and ambient temperatures of the various transportation activities. Refer to **6.2 Calculate dry ice amount for container shipment**.

It is very important to estimate the duration of the activities in the shipment schedule and the ambient temperatures that the container will be exposed to as accurately as possible. Both of these factors have a large impact on the container performance. In case of doubt, it is always better to overestimate both duration and temperature.

6.1 CALCULATE DRY ICE AMOUNT FOR CONTAINER PRE-CONDITIONING

NOTE!

Only applicable if the container shall be pre-conditioned using dry ice.

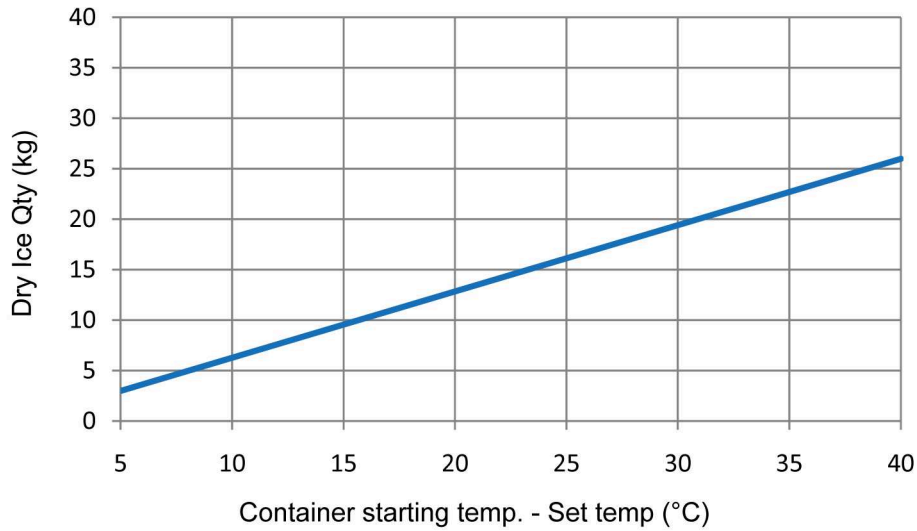
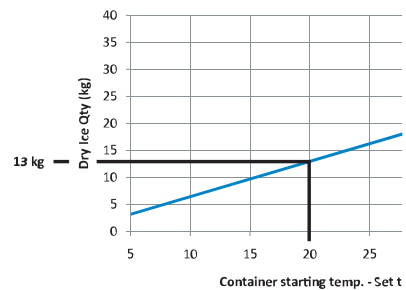

Fig. 44

1. Note the current container temperature (°C). An estimate based on the ambient temperature is acceptable.
2. Determine the required set temperature (°C) for the cargo.
3. Subtract the "set temperature" from the "container temperature" to obtain a temperature difference.
4. Refer to the graph in **Fig. 44**. Locate the "temperature difference" from step 3 on the horizontal axis.
5. Read upwards to the blue line and then across to the vertical axis to determine the dry ice quantity (kg) required for container pre-conditioning.

Calculation example

1. The current container temperature is 25 °C.
2. The required set temperature for the cargo is 5 °C.
3. $25 - 5 \text{ °C} = 20 \text{ °C}$.
4. Refer to the graph in **Fig. 44**. Locate **20 °C** on the horizontal axis.
5. Read upwards to the blue line and then across to the vertical axis. The amount of dry ice required for container pre-conditioning is **13 kg**.



6.2 CALCULATE DRY ICE AMOUNT FOR CONTAINER SHIPMENT

Table 12 Example: Matrix

Activity	Time (h)	Ambient temp (°C)	Product (Time x Ambient temp)
Loading / truck to airport	2	20	2 x 20 = 40
Tarmac / aircraft loading	2	25	2 x 25 = 50
Flight time	8	15	8 x 15 = 120
Aircraft unloading	2	28	2 x 28 = 56
Warehouse at destination	11	23	11 x 23 = 253
TOTAL TIME	25	PRODUCT SUM	519

1. Make a matrix containing the following information (see example in **Table 12**):
 - The estimated time for each activity in the shipment schedule, from container pre-conditioning to the time the cargo is unloaded, and the total time for all activities.
 - The estimated ambient temperature for each activity (check the weather forecast).
 - The product of time multiplied with ambient temperature for each row.
 - The product sum of all activities added.
2. Determine the average ambient temperature by dividing the product sum by the total time.
3. Determine the required set temperature (°C) for the cargo, and locate the dry ice table for the set temperature in **7. Dry ice tables**.
4. Locate the applicable “Ambient temperature” column and “Hours” row based on the average ambient temperature calculated in step 2 and the total time calculated in step 1. Round the values as required.
5. Read across the row and down the column to where they meet to determine the required dry ice amount (kg). If applicable, add the amount of dry ice required for pre-conditioning.

Calculation example

1. See **Table 12**.
2. Product sum: 519. Total time: 25. $519 / 25 = 20.7$ °C
3. The required set temperature for the cargo is 5 °C. The applicable dry ice table is **7.1 Set temperature +5°C**.
4. Under **Ambient temperature**, locate 20 °C. Under **Hours**: Locate 25. See example in **Table 13**.
5. Read across and down to where the “25” row and “20 °C” column meets. The amount of dry ice required for the container shipment is **35** kg.
Add the dry ice required for pre-conditioning (section **6.1**): 13 kg + 35 kg = **48** kg.

Table 13 Example: Dry ice quantity required (excerpt from dry ice table for set temperature +5 °C)

Hours	Ambient temperature				
	10 °C (50 °F)	15 °C (59 °F)	20 °C (68 °F)	25 °C (77 °F)	30 °C (86 °F)
10	30	30	30	30	30
15	30	30	30	30	35
20	30	30	30	35	45
25	30	30	35	45	55

7. DRY ICE TABLES

For information on how to use the dry ice tables, refer to **6. Calculating dry ice amounts**. For cargo to be shipped at set temperatures for which no dry ice table is included in this manual, use the online dry ice calculation tool in the Envirotainer Portal: portal.envirotainer.com or contact Envirotainer for advice.

If the required amount of dry ice exceeds the bunker capacity (**8. Technical specification**), plan to re-ice the container. Refer to **4.4.7.3 Re-icing the container**.

i NOTE!

The dry ice quantity is expressed in kilograms. 1 kg = 2.2 lbs.

7.1 SET TEMPERATURE +5°C

Hours	Ambient temperature				
	10 °C (50 °F)	15 °C (59 °F)	20 °C (68 °F)	25 °C (77 °F)	30 °C (86 °F)
10	30	30	30	30	30
15	30	30	30	30	35
20	30	30	30	35	45
25	30	30	35	45	55
30	30	30	40	55	70
35	30	35	50	65	80
40	30	35	55	70	90
45	30	40	60	80	100
50	30	45	70	90	110
55	30	50	75	100	120
60	30	55	80	105	135
65	30	60	85	115	145
70	35	65	95	125	155
75	35	70	100	135	165

7.2 SET TEMPERATURE -20°C

Hours	Ambient temperature			
	10 °C (50 °F)	15 °C (59 °F)	20 °C (68 °F)	25 °C (77 °F)
10	36	42	48	54
15	54	63	72	81
20	72	84	96	108
25	90	105	120	135
30	108	126	144	162
35	126	147	168	N/A
40	144	168	N/A	N/A
45	162	N/A	N/A	N/A

8. TECHNICAL SPECIFICATION

REFRIGERATION SYSTEM

Thermostat-controlled heat exchanger powered by 16 D-cell alkaline batteries, and using dry ice as refrigerant.

Max dry ice bunker capacity when using block ice (up to 50% less capacity if dry ice pellets are used) 180 kg (397 lbs)

Cooling range (desired temperature in the container) -20 to +20 °C (-4 to +68 °F)

Temperature tolerance in cargo space

- at set temp +5 °C (+41 °F)* ± 3 °C (± 5.4 °F)

- at set temp +15 °C (+59 °F)* ± 5 °C (± 9 °F)

DIMENSIONS

External cube (volume) 4.8 m³
(168 ft³)

External dimensions (L x W x H) 2007 x 1534 x 1626 mm
(79 x 60.4 x 64")

Main loading space (L_{load} x W_{load} x H_{load}) 1415 x 1355 x 1360 mm

Note free space requirements in front of the fan area (55.7 x 53.3 x 53.5")

— refer to **8.2 Loading space**.

Additional loading space (not right-angled) below dry ice bunker (l x w x h) 430 x 1355 x 860 mm
(16.9 x 53.3 x 33.8")

Door opening (L x H) 1415 x 1360 mm
(55.7 x 53.5")

Internal cube (volume) 2.93 m³
(103.4 ft³)

WEIGHT

Tare weight** 265 kg
(584 lbs)

Max gross weight (including dry ice) 1,588 kg
(3,500 lbs)

Max net weight** 1,323 kg
(2,916 lbs)

OTHER INFORMATION

Suitable for use on aircraft A300, A310, A330, A340, A350, A380, B747, B767, B777, B787, DC10, IL86, MD11, L1011. For other aircrafts, alternative operating procedures may apply.

Forkliftable with a slot-height of 95 mm (3.7 in), slot-width of 290 mm (11.4 in).

**Provided that the ambient temperature is 5 to 25 °C (9 to 45 °F) above the set temperature.*

***The tare weight (and thereby the max net weight) may change due to repairs.*

8.1 DEFINITION OF DIMENSIONS

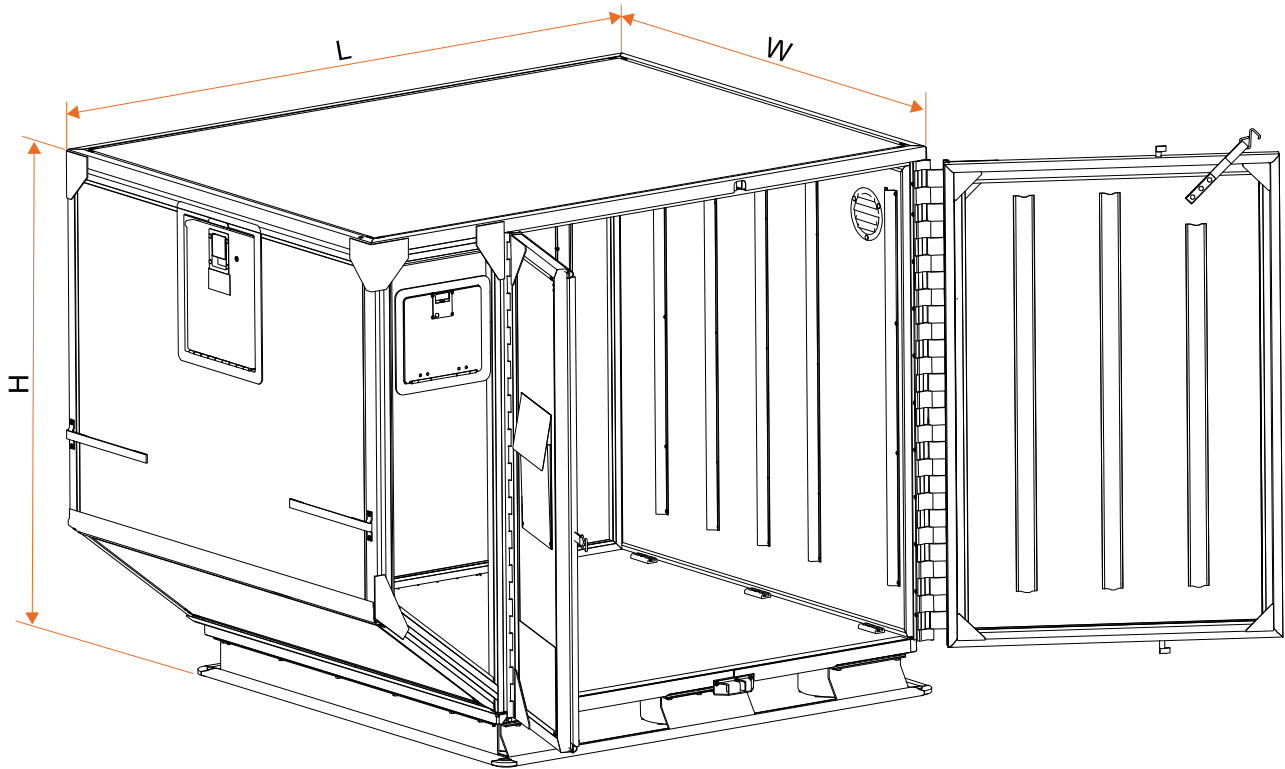
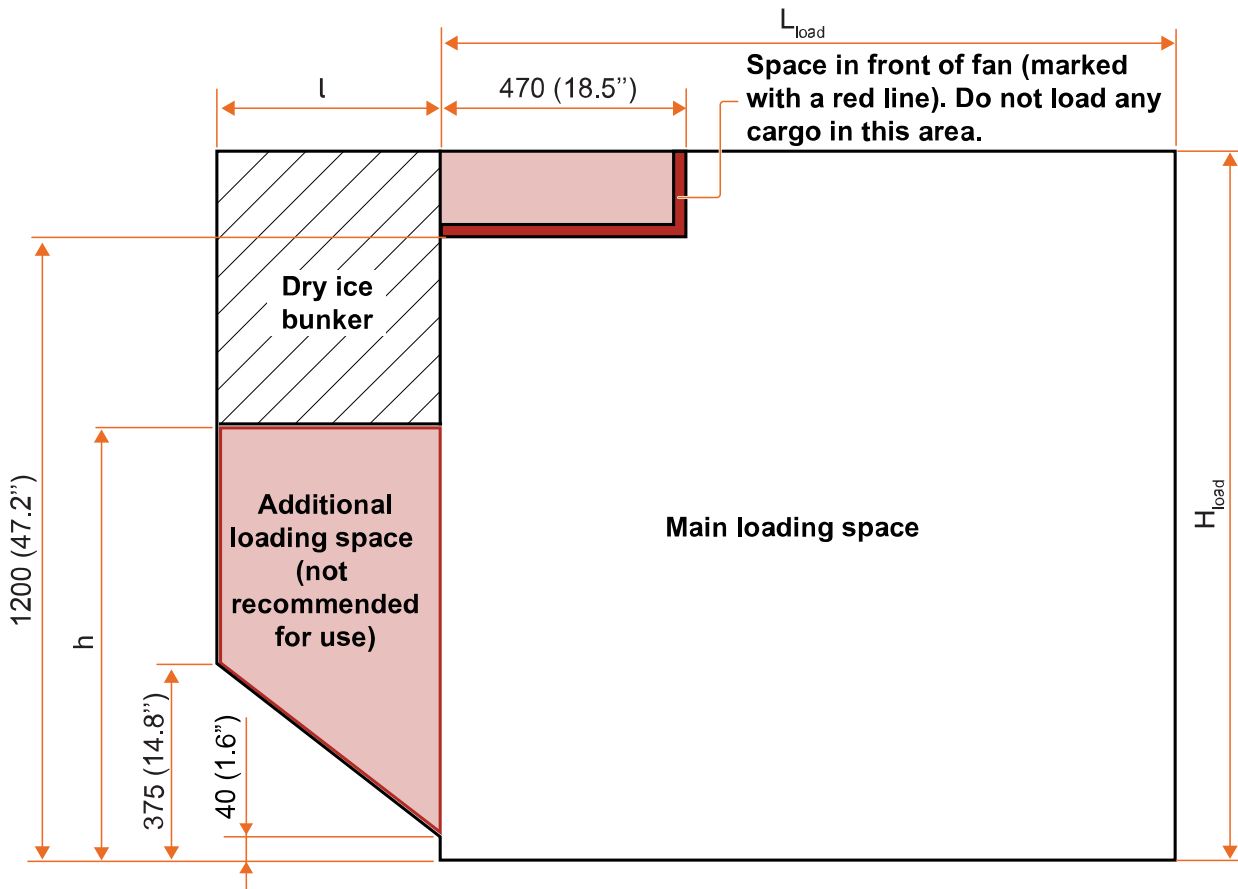

Fig. 45

G00005290

8.2 LOADING SPACE



G00005291

Fig. 46 Loading space, side view

Intentionally left blank

Envirotainer Engineering AB

www.envirotainer.com

Doc No:	Revision:	State	Release date:	Approved by
MO-RKN-3062	28	Released	2025-06-13	lindaw